



# **NMR Probes & Accessories Catalog**

Fluorine Quad H/F/X/Y

Solids/Liquids MAS

High Temperature MAS

Liquids PFG/Diffusion

Liquids HR

High Temp Liquids and PFG



# Doty NMR

## TABLE OF CONTENTS

### 2023

	<u>PAGE</u>
<b>PROBES</b>	
H/F/X/Y Fluorine Quad MAS .....	1
NB H/X or H/X/Y MAS Probes – <i>with Low E Fields</i> .....	3
WB Ultra Range H/X or H/X/Y Probes – <i>Some Down to -180°C</i> .....	5
WB Ultra Range H/X or H/X/Y Probes – <i>Some Up to +500°C</i> .....	6
Liquids NMR and PFG/Diffusion Probes – XVT up to <i>+300°C</i> .....	7
Liquids Diffusion/PFG (Pulsed Field Gradient) Z Gradient Probes .....	8
Custom Liquids High-Resolution NMR Probes.....	9
Magic Angle Gradient MAS .....	11
SAS (Switched Angle Spinning) .....	13
Wideline Probes.....	13
Wide-line <b>NB</b> High-Temperature (-110 to 250 °C) 3 mm H/X Probes .....	13
<b>ACCESSORIES</b>	
<b>BENCH SPINNERS AND SPIN RATE MONITORING</b>	
Bench Spinner Assemblies .....	14
Spin Rate Detection and Regulation (Preamp/Power Supply <i>tachometer</i> and Cables).....	14
Digital Frequency Counter.....	14
Filtered Dual Air Regulator .....	14
<b>TEMPERATURE CONTROL ACCESSORIES</b> .....	15
Probe Exhaust Dewar .....	15
50 Liter Nitrogen Dewar .....	15
Cold-Gas Supply Systems .....	15
<b>SUPPLIES</b>	
General Accessories (Air connectors, paints, glues) .....	16
<b>SPINNER SUPPLIES</b>	
<b>DI-3:</b> Accessories for 3 mm DI Spinners.....	17
<b>DI-4:</b> Accessories for 4 mm DI Spinners .....	18
<b>Sealing Cells</b> for XC and DI Liquids and Semi-solids .....	20
<b>Rotors</b> for the XC and SuperSonic (SS) MAS Spinners .....	21
<b>XC:</b> Accessories for the XC MAS Spinners .....	22
<b>SuperSonic (SS):</b> Accessories for the SuperSonic (SS) MAS Spinners .....	23
<b>High-Speed:</b> Accessories for 5 mm and 7 mm MAS.....	24
<b>Standard:</b> Accessories for 5 mm and 7 mm MAS.....	25
<b>APPENDIX</b>	
<b>DOTY SPINNER ASSEMBLY MATERIALS</b> .....	26
Plastics, O-ring Caps, & Extended Temperature Caps.....	26
Ceramics .....	27
Doty MAS Spinning Speeds .....	28
3mmMAS Spinning Speeds .....	29
TYPICAL SPECIFICATIONS FOR SOLIDS PROBES .....	30
<b>ORDERING INFORMATION</b> .....	31
<b>SALES OFFICES</b> .....	32

catalog information may be updated at any time. [www.dotynmr.com](http://www.dotynmr.com)



## The XVT UHF Quad-MAS H/F/X/Y

- Dedicated  $^{19}\text{F}$  and  $^1\text{H}$  channels for simultaneous operation of  $^1\text{H}$  and  $^{19}\text{F}$
- $^1\text{H}$  and  $^{19}\text{F}$  high-power decoupling with amazing isolation, efficiency, stability, and VT range
- 2 Broadband channels, X/Y
- Extended VT range:  $-180$  to  $+150$  °C

**ULT UHF HFX Y DNP is coming**

### H/F/X/Y – Representative RF Performance, NB, Quad-tuned configuration

$^1\text{H}$ Freq	Rotor	$^1\text{H}$ $\pi/2$ , P	$^{19}\text{F}$ $\pi/2$ , P	$^{13}\text{C}$ (X) $\pi/2$ , P	$^{15}\text{N}$ (Y) $\pi/2$ , P
500 MHz	3 mm	2.0 $\mu\text{s}$ , 250 W	2.0 $\mu\text{s}$ , 200 W	2.5 $\mu\text{s}$ , 600 W	4.0 $\mu\text{s}$ , 600 W
300 MHz	1.3 mm	1.2 $\mu\text{s}$ , 250 W	1.2 $\mu\text{s}$ , 200 W	1.4 $\mu\text{s}$ , 330 W	2.0 $\mu\text{s}$ , 450 W
500 MHz	1.3 mm	1.4 $\mu\text{s}$ , 160 W	1.3 $\mu\text{s}$ , 160 W	2.0 $\mu\text{s}$ , 300 W	3.0 $\mu\text{s}$ , 400 W
800 MHz	1.3 mm	1.6 $\mu\text{s}$ , 230 W	1.4 $\mu\text{s}$ , 240 W	2.0 $\mu\text{s}$ , 680 W	3.6 $\mu\text{s}$ , 700 W
1200 MHz	1.3 mm	2.0 $\mu\text{s}$ , 200 W	1.7 $\mu\text{s}$ , 200 W	2.4 $\mu\text{s}$ , 650 W	4.0 $\mu\text{s}$ , 750 W

*MAS on a Previous Generation 3 mm Doty H/F/X/Y  
500 MHz Probe In the 4 Channel Tuning Mode*

$^{13}\text{C}$  observe, simultaneous  $^1\text{H}/^{19}\text{F}$  decouple

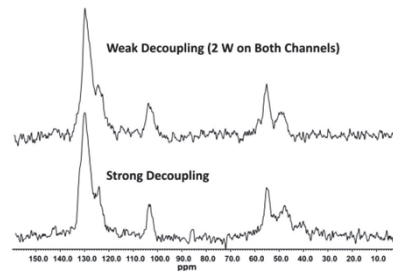

$^{13}\text{C}$  NMR of fluoropolymer, Viton, 24 kHz MAS, with simultaneous  $^1\text{H}$  and  $^{19}\text{F}$  decouple

*(Also H/F or  
H/F/X Probes)*

### Temperature Dependence of $^{19}\text{F}$ NMR - Viton

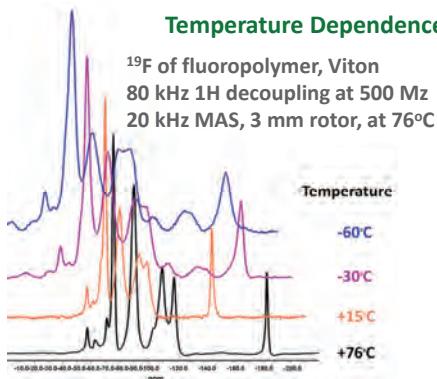

Expansion of the Region  
100 to 220 ppm of the  $^{19}\text{F}$   
MAS of Viton

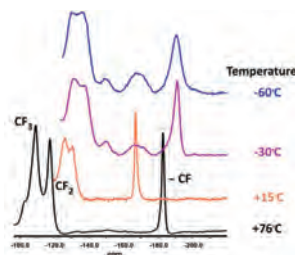

**Acknowledgement:  
NIH R44GM119937**

## Fluorine Quad H/F/X/Y HR-Solids

Solids Quad Resonance

*4 Efficient, High Power RF Channels*

- Dedicated  $^{19}\text{F}$  and  $^1\text{H}$  channels for  $^1\text{H}$  and  $^{19}\text{F}$  operation simultaneously
- Enables  $^1\text{H}$  and  $^{19}\text{F}$  high-power decoupling (and  $^2\text{H}$  decoupling on the X channel)
- 2 Broadband channels, X/Y
- High resolution
- Extended VT range: NB -150 to +150°C

*MAS on a Previous Generation 3 mm Doty H/F/X/Y  
500 MHz Probe In the 4 Channel Tuning Mode*

Temperature Dependence of  $^{19}\text{F}$  NMR - Viton

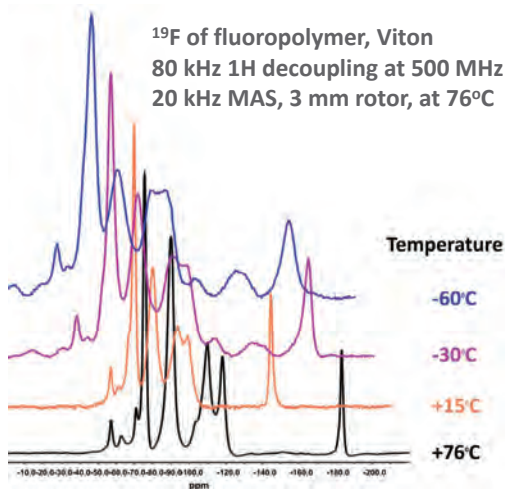

Expansion of the Region 100 to 220 ppm of the  $^{19}\text{F}$  MAS of Viton

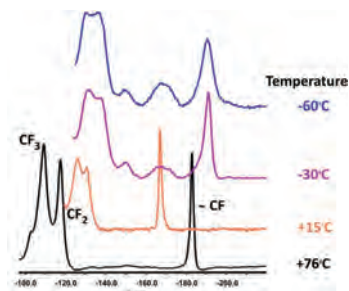

500 MHz, NB, H/F/X/Y  
3 mm MAS Probe with  
2 Broadband Channels

$^{19}\text{F}$  MAS (18 kHz) of Viton  
No increase in noise during decoupling

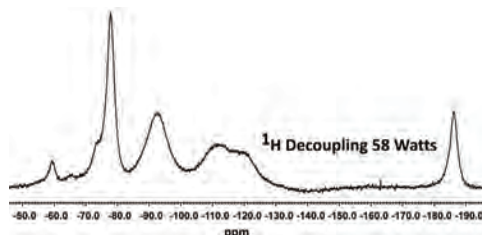

$^{13}\text{C}$  MAS (24 kHz) of Viton,  $^1\text{H}$  and  $^{19}\text{F}$   
decoupling with low noise and excellent  
isolation between the  $^1\text{H}$  and  $^{19}\text{F}$  channels

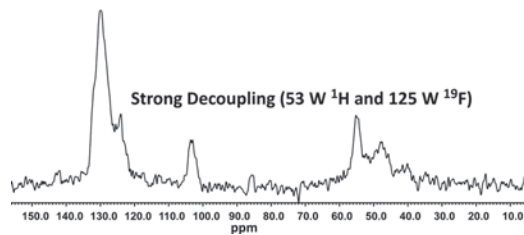

Acknowledgement:  
NIH R43GM119937



For S/N, RF field Strength, and Extended Temperatures.  
H/X or H/X/Y.

- **Low E  $^1\text{H}$  Coil**
- **High-Q solenoid for X and Y**
- **Highest S/N:**  
4 mm  $^{13}\text{C}$  – S/N of 205:1 on 50 mg of Glycine  
3 mm  $^{13}\text{C}$  – S/N of 103:1 on 18 mg of Glycine  
S/N of 258:1 on 18 mg of HMB  
*(spectrum below)*
- **Highest rf Field Strength and Efficiency:**  
 $^{13}\text{C}$   $\pi/2$  pulse of 1.3  $\mu\text{s}$  with only 640 W at 125.7 MHz. 3 mm Bmax with H/X tuning.
- **Wide VT Ranges**  
Standard VT Range  
-80°C / +120°C for NB  
Extended VT Range  
-150°C / +150°C for NB
- **Low Thermal Gradients**

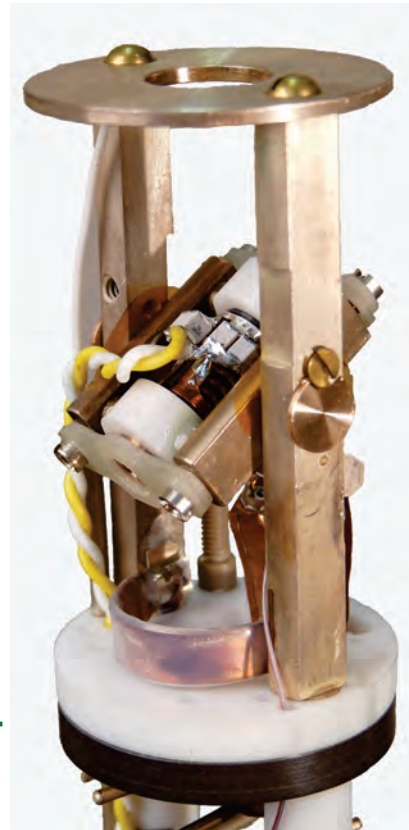

NB 3 mm **Bmax** MAS with low E outer decoupling coil, and inner X/Y solenoid.

**MQMAS on kyanite, 3 mm Bmax**

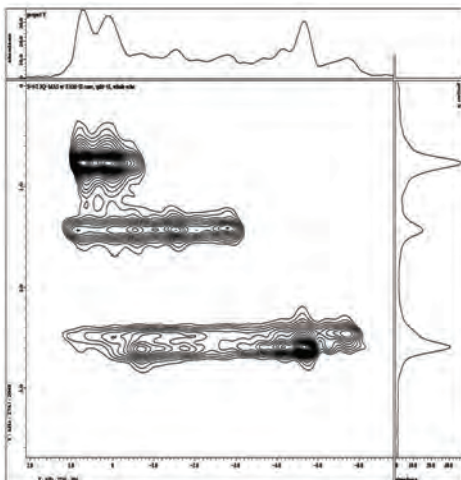

Artifact free MQMAS 2D spectrum on  $5/2$   $^{27}\text{Al}$  transition of kyanite at 500 MHz.

Spectrum: Mike Frey (Jeol), Paul Ellis, and George Entzminger (Doty Scientific).

**HMB (18 mg) 3 mm Bmax CP/MAS**  
 $^{13}\text{C}$  at 500MHz H/C tuning, S/N 258:1

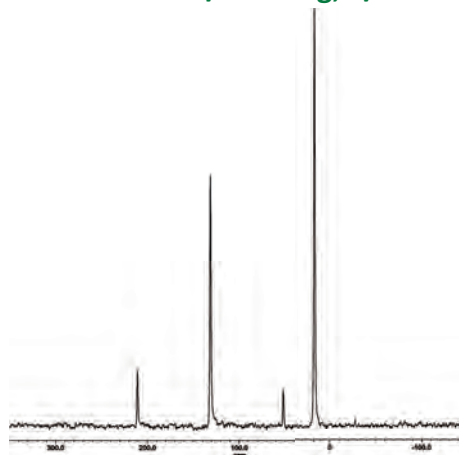

During CP  $\gamma\text{B}_1/2\pi$  was 58.5 kHz with powers of  $^1\text{H}$  at 92.5 W and  $^{13}\text{C}$  at 53.0 W.

# Doty NB H/X or H/X/Y MAS Probes

For Superior S/N, Homogeneity, and Fast Stable Spinning

Compatible with Bruker, JEOL, Agilent, Tecmag, and Q.One

## Extraordinary Homogeneity

4 mm Bmax MAS, H/X,  $^{13}\text{C}$  at 500 MHz

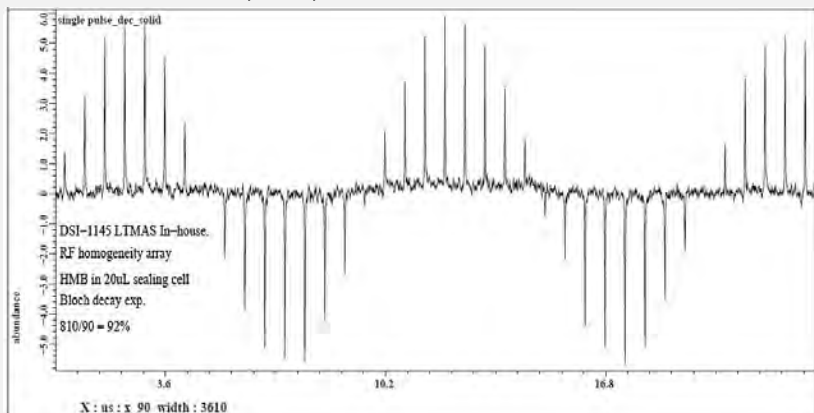

## Highest S/N

4 mm Bmax CP/MAS at 500 MHz  
S/N=205:1,  $^{13}\text{C}$   $\alpha$ -glycine (49.7 mg)  
4 scans

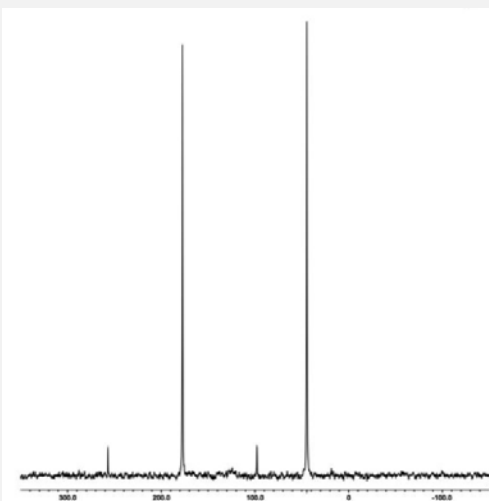

$^1\text{H}$  with 97.4 W and  $^{13}\text{C}$  with 53 W.  $^1\text{H}$  decoupling 97.4 kHz TPPM, ramped-CP at 62 kHz for 7.5 ms, 10 kHz MAS.

## Exceptional RF Field Strength

3 mm Bmax MAS, H/X, 500 MHz,  $^1\text{H}$   $1.3 \mu\text{s} \pi/2$  for  $^{13}\text{C}$  with 640 W and 75 kHz  $^1\text{H}$  decoupling

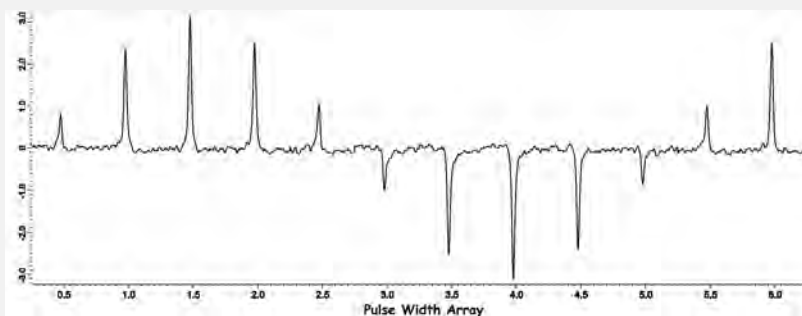

Nutation plot for  $^{13}\text{C}$  Bloch decay using HMB. The methyl carbon is the only resonance displayed.

3 mm Bmax CP/MAS, at 500 MHz  
SN=103:1,  $^{13}\text{C}$   $\alpha$ -glycine (21.9 mg),  
4 scans

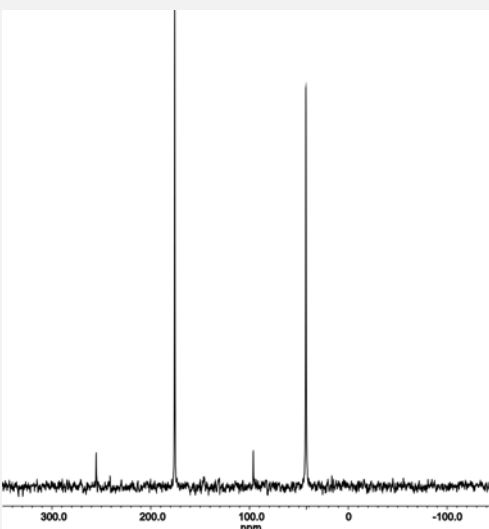

$^1\text{H}$  with 97.5 W and  $^{13}\text{C}$  with of 53 W. During CP,  $\gamma\text{B}_1/2\pi$  was 58.5 kHz. 10 kHz MAS.

## Narrow Bore Sample Temperatures:

-80°C to +120°C for Standard VT Range  
-150°C to +150°C for XVT (extended VT)

## MAS Spinner Assembly Options

3 mm DI-3	Drop-in	28 kHz
4 mm DI-4	Drop-in	18 kHz
4 mm XC4		22 kHz
5 mm XC5		18 kHz



**Standard VT or  
Low Temperature  
WB Ultra-Range MAS**

The Low Temperature model provides operation down to **-180 °C**. 3 mm only.

- For WB Magnets Only, 300 MHz to 700 MHz

---

- Broad Temperature Ranges  
Standard VT: -140 °C to +170 °C  
Low Temperature (LT): -180 °C to +170 °C

---

- Broad Tuning Range  
with tuning inserts  $^{31}\text{P}$  to  $^{103}\text{Rh}$

---

- Double-Tuned  $^1\text{H}/\text{X}$  or Triple-Tuned  $^1\text{H}/\text{X}/\text{Y}$   
Note: the  $^1\text{H}/\text{X}/\text{Y}$  triple-tuned probe can be converted to double-tuned  $^1\text{H}/\text{X}$  by disconnecting the third channel.

---

- Broad Range of Standard VT Spinner Options  
3, 4, 5, or 7 mm

---

- Low Thermal Gradients,  $\leq 4$  °C Over Sample Length

---

**Extended VT or  
High Temperature  
WB Ultra-Range MAS**

The High Temperature model provides operation up to **+500 °C**. 5 mm only.



- For WB Magnets Only, 300 MHz to 700 MHz

---

- Broad Temperature Ranges
  - Extended VT (XVT): -140 °C to +260 °C
  - High Temperature (HT): -100 °C to **+500 °C** 5 mm Only

---

- Broad Tuning Range
  - with tuning inserts  $^{31}\text{P}$  to  $^{103}\text{Rh}$

---

- Double-Tuned  $^1\text{H}/\text{X}$  or Triple-Tuned  $^1\text{H}/\text{X}/\text{Y}$ 
  - Note: the  $^1\text{H}/\text{X}/\text{Y}$  triple-tuned probe can be converted to double-tuned  $^1\text{H}/\text{X}$  by disconnecting the third channel.

---

- Broad Range of XVT Spinner Options
  - 3, 4, 5 or 7 mm

---

- Low Thermal Gradients,  $\leq 4$  °C Over Sample Length

---



## Liquids Probes also with Powerful Z Gradients

- NB or WB.
- Extended Temperature (XVT) to **+300 °C** with sample size 5 mm
- Standard VT -40 °C to +60 °C with sample sizes 5 mm to 20 mm
- Many tuning options: H/X/lock, H-F/X/lock, H/C/N/lock, H/F/X/lock.
- Pulsed gradient >3000 G/cm with water cooled Z-gradient.



HR Liquids  
NMR Probe  
without gradient



XVT Liquids Probe  
with Z gradient coil  
H-F/X/<sup>2</sup>H Lock  
300 °C, 5mm NB

*Access a wide range of temperatures. Shown here is the temperature dependence of the <sup>13</sup>C spectrum of Nylon 6,6 in silicone oil.*

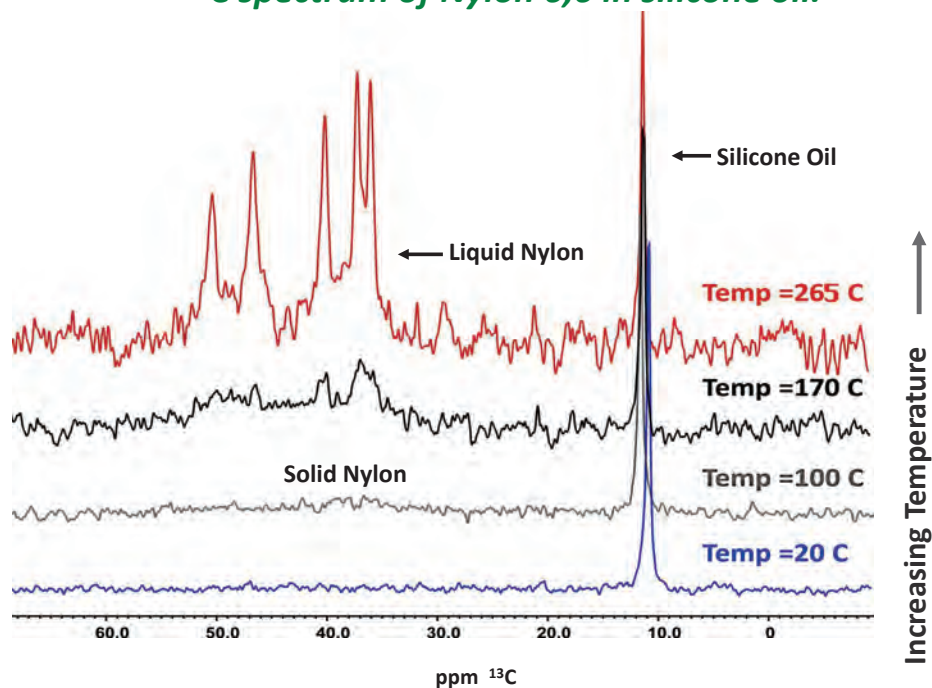



# Liquids PFG/Diffusion Z Gradient Probes

- High magnetic fields up to 900 MHz
- Measures lowest diffusion coefficients – to  $10^{-15}$  m<sup>2</sup>/s
- Optimized for minimal eddy currents
- Highest strength gradients
- Best thermal stability
- Excellent mechanical stability
- Exceptional gradient uniformity (~1%) over a large sample volume.
- High spectral resolution
- <sup>1</sup>H/X, direct or indirect detect

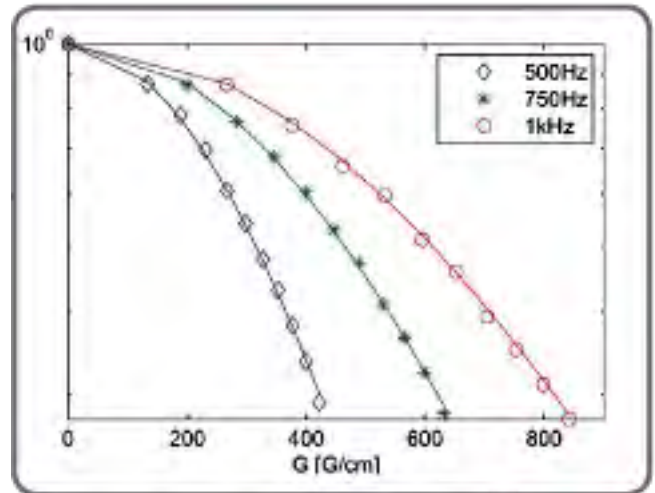

## Doty 300MHZ, 16-38 Z Gradient, Diffusion Probe Results

Experimental (markers) and fitted (lines) signal attenuation as a function of diffusion gradient amplitudes and frequencies; oscillating gradient spin echo (OSGE).

Courtesy of: Junzhong Xu and Prof. John Gore, Vanderbilt University, Nashville, TN, US

Now up to +300 °C



### Sample Temperature Ranges:

Std VT range, NB or WB: -100/+160C with water cooling  
 Std VT range, NB or WB: -50/+80C with air cooling  
 5mm XVT, NB or WB, 20-40c: -140/+300C, water cooling  
 8mm XVT, NB or WB, 20-40c: -100/+160C, water cooling

Gradient Coil Parameter	Model 16-38	Model 20-40C	units
Outside diameter	38	39	mm
Diameter of rf shield	16	20	mm
Clear I.D.	14	17.5	mm
Cooling method	Water*	Water*	
Continuous gradient	341	180	G/cm
Continuous gradient	3.4	1.8	T/m
Pulse gradient	3320	1380	G/cm
Duty Cycle	1.1%	1.7%	
Gradient gain, $\alpha$	455	180	mT/A/m
Continuous current	7.5	10	A
Peak current	73	77	A
$d_i$ for 4% local deviation	6	12	mm
$z_i$ for 4% local deviation	11	28	mm
DC resistance, $R_E$	1.7	1.6	$\Omega$
Inductance, $L$	158	209	$\mu$ H
Slew rate, $\alpha V/L$ , at 1 V	2870	860	T/m/s

\*Air cooling is possible, but results in a 50% reduction in current for a given duty cycle.

## Custom Liquids High-Resolution NMR Probes

PFG, Inverse, MRI,  
Quad-Tuned and more

Many in the field of NMR immediately relate Doty Scientific with Solids NMR. We are proud of our contributions to NMR Solids, however, we would like people to know more about our contributions to liquids NMR as well.

Doty Scientific, an established leader in large-sample high-resolution (liquids) coil technology and solids NMR, is using the latest in laser cutting, compensated laminates, and thermal gradient minimization with alumina coilforms to bring its Super-B<sub>1</sub> coils to the field of high-resolution liquids NMR.

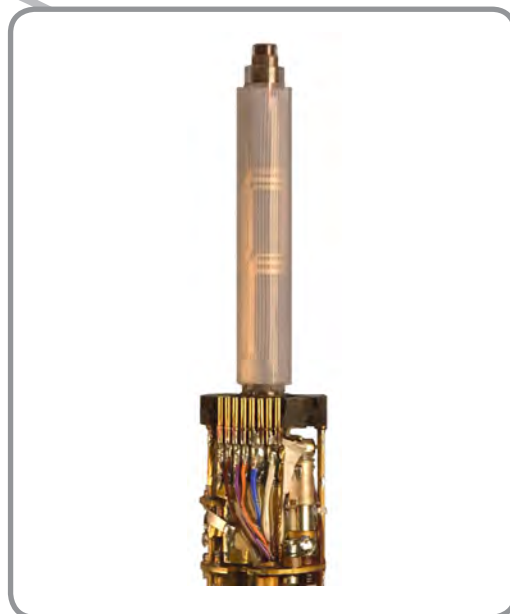

### Examples of custom liquids high-resolution probes

25 mm	<sup>1</sup> H/X 400 MHz WB, Perfusion
10 mm	<sup>1</sup> H/ <sup>19</sup> F/X/lock, 400 MHz WB, Multi-X, Triple
10 mm	<sup>1</sup> H/X/Y/lock, 500 MHz NB, Multi-X, Multi-Y, Triple
10 mm	<sup>1</sup> H/X/lock, 300 MHz WB, Multi-X, -170 °C to 500 °C
5 mm	<sup>1</sup> H/X/lock, 600 MHz NB, Inverse, PFG, 220 G/cm continuous
5 mm	<sup>1</sup> H/ <sup>19</sup> F/X/Y, 300 MHz NB, Inverse, Triple, PFG, -170 °C to 300 °C
15 mm	<sup>1</sup> H/X, 600 MHz NB, Multi-X, Microscopy, 25 G/cm continuous
15 mm	<sup>1</sup> H/ <sup>19</sup> F/X, 600 MHz WB, Electrophoresis, PFG, 140 G/cm continuous
40 mm	<sup>1</sup> H/ <sup>19</sup> F, 400 MHz WB, Microscopy Clear Bore, 14 G/cm continuous
18 mm	<sup>1</sup> H/X/lock, 600 MHz, NB, Perfusion
5 mm	<sup>1</sup> H/X/lock, 1067 MHz (1.07 GHz) NB Multi-X, PFG, 77 G/cm continuous
10 mm	<sup>1</sup> H/X/lock, 300 MHz WB, High Temp PFG, 500 °C







... For gradient spectroscopy  
and diffusion.

Ultra-high gradients

400 G/cm PFG at 14 T

Exceptional recovery

High resolution

Wide VT range

H/X/Y/lock

NB or WB Probes



500 MHz, H/X  
4 mm NB MAS Probe with  
Magic Angle Gradients

## MAS NMR data:

solids (powder)

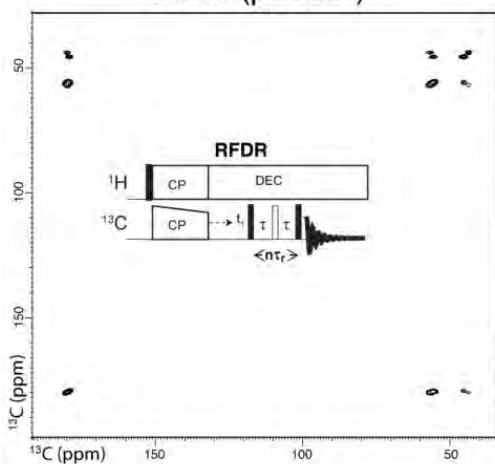

semi-solids

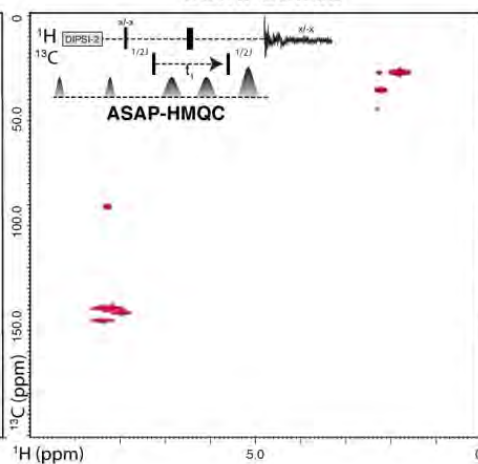

viscous liquids

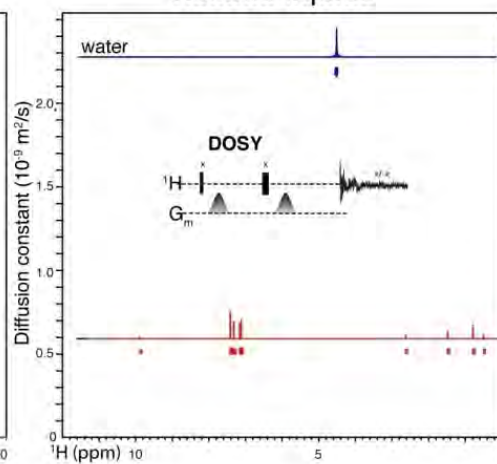

A) Radio frequency driven rotational resonance (RFDR)  $^{13}\text{C}/^{13}\text{C}$  correlation spectrum of uniform  $^{13}\text{C}$ ,  $^{15}\text{N}$ -Leucine powder, 4 scans;

B) Inverse  $^1\text{H}$  detected heteronuclear multiple quantum correlation spectrum of 4-cyano 4'-biphenyl nematic liquid crystals in natural abundance, 2 scans;

C) Single-scan diffusion-ordered 2D spectra of 4-cyano 4'-biphenyl in chloroform and water.



For MAS Diffusion and Gradient Spectroscopy

### <sup>1</sup>H MAS Diffusion NMR

Using a 4 mm <sup>1</sup>H/X Probe

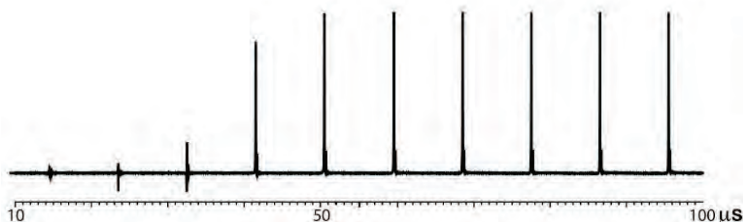

Gradient Recovery Time (ms) at 100 G/cm PFG

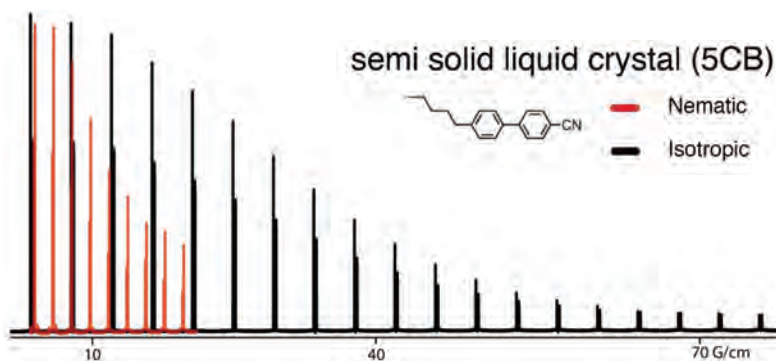

Simulated-Echo-PFG <sup>1</sup>H Diffusion NMR

### <sup>19</sup>F MAS Diffusion NMR

Using a 4 mm <sup>1</sup>H/<sup>19</sup>F/X Probe

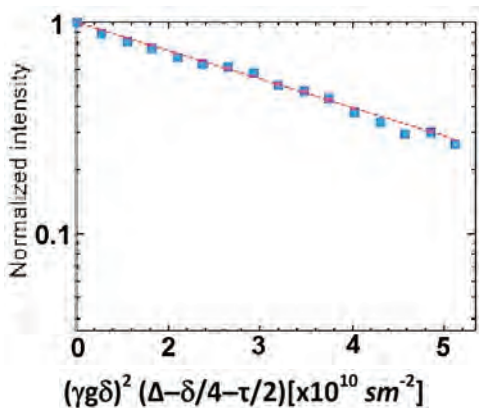

PGSE decay curve with diffusion time of 30 ms. The self-diffusion coefficient for F<sup>-</sup> at 40°C in polymeric fluoride ion conductor was measured to be in the 2x10<sup>-10</sup> - 4x10<sup>-10</sup> m<sup>2</sup>s<sup>-1</sup> range depending on the type of material.

Doty Scientific would like to thank Dr. F. Ziarelli and Prof. Dr. S. Viel, Aix-Marseille Université. Pasquini et al., *ChemPhysChem*. 2015, 17, 363.

### <sup>1</sup>H CRAMPS NMR

Using a 4 mm <sup>1</sup>H/X Probe

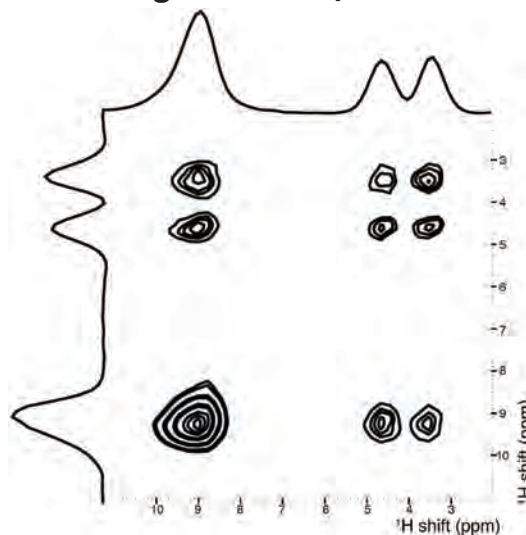

Two-dimensional <sup>1</sup>H detected homonuclear correlation spectrum of Glycine powder. 300 MHz <sup>1</sup>H spectrum was recorded under 7 kHz MAS and wPMLG3 acquisition.

## SAS – Switched Angle Spinning Probes



In response to the new applications for SAS, we have developed a SAS probe with more durable, fatigue-resistant leads – for up to 500,000 flips before replacement. Precise computer control of angle setting (via a servo motor) results in magic angle setting reproducibility during SAS of  $>0.015^\circ$ , with a 60 ms settling time. Tuning can be H/X or H/X/Y with 3, 4, or 5 mm spinners. For Wide bore magnets only. A manually controlled goniometer probe for Variable Angle Spinning (VAS) is also available for WB magnets.

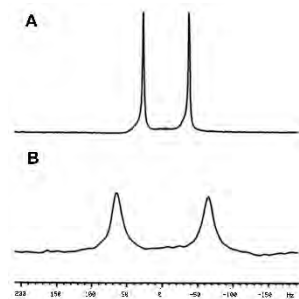

**$^2\text{H}$  Quadrupolar Splitting for  $\text{D}_2\text{O}$  in Bicelles.**

- A) spectrum for sample rotating at  $\theta=80^\circ$ .  
 B) spectrum on rotating sample obtained with SAS from  $\theta=80^\circ$  to  $\theta=10^\circ$ .

Laura Holte, Doty Scientific, Inc.

## Wideline Probes

The wide range of available options listed below offers exceptional versatility, usually all you'll need.

However we also offer unique probes – such as *the wideline 3 mm narrow bore H/X probe* (shown below) *with a temperature range to 250 °C and impressively low  $^1\text{H}$  background signals.*

### Available options:

- ◆ 3 mm, 4 mm, 5 mm, 7 mm, 8 mm, or 10 mm (WB only) sample
- ◆ Wide Bore or Narrow Bore probe
- ◆ -80°C to 120°C, Standard VT for NB
- ◆ -160°C to 200°C, XVT for NB
- ◆ -110°C to 150°C standard VT for WB
- ◆ -170°C to 250°C, XVT for WB
- ◆ H/X, Double resonance with multinuclear observe
- ◆ H/X/Y, Triple resonance with multinuclear observes
- ◆ A low cost  $^2\text{H}$  only option is available, which can be tuned for use at more than one field strength

A probe is delivered with ten sample containers and 20 plugs.

$^2\text{H}$  Quad Echo data on a JEOL ECA600 and a Doty  $^2\text{H}$  Wideline Probe tuned for Use at 9.4, 11.7, and 14.1 T.

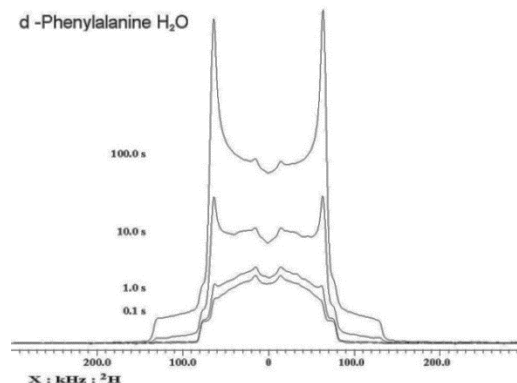

The times above indicate relaxation delay. The probe is tunable to  $^2\text{H}$  at 400, 500, or 600 MHz  $^1\text{H}$  freq. Courtesy of Michael Frey, JEOL USA.

## Wideline 3 mm NB H/X Probe to 250 °C

- **Ceramic Housing and Coil Support Enables:**
  - High Temperature Operation
  - Protection of the Coil and Sample
  - Minimal Background Signals
  - (Ultra Low  $^1\text{H}$  Background Option)
- **High-power decoupling**
  - 1.5  $\mu\text{s}$   $^1\text{H}$   $\pi/2$  pulse at 600 MHz with 230 W
  - 2.5  $\mu\text{s}$   $^{13}\text{C}$   $\pi/2$  pulse at 150.9 MHz with 350 W
- H/X, Double resonance with multinuclear observe
- H/X/Y, Triple resonance with multinuclear observe
- **Extended VT range: NB -110 °C to 250 °C (WB -110 °C to 320 °C)**

Sample temperature measured by  $^{207}\text{Pb}(\text{NO}_3)_2$  chemical shift

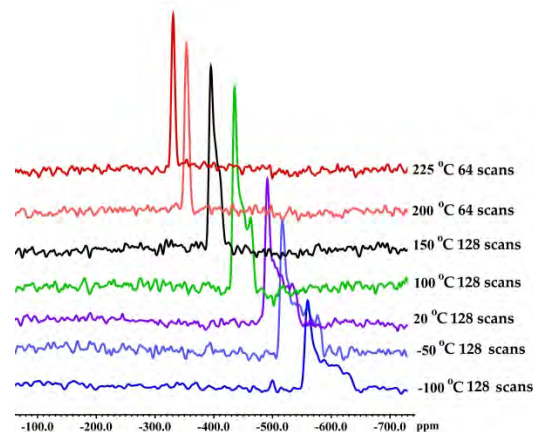



## Bench Spinner Assemblies

Bench spinners enable researchers to spin-pack samples and test sample balance on the bench. Some stators in bench spinner assemblies have thicker walls for added durability.

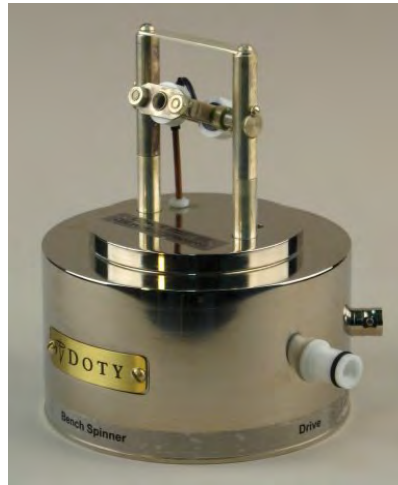



### Bench Spinners \*

# 95701	3 mm DI.....	\$14,128
# 95723	4 mm DI.....	13,560
# 95719	4 mm XC .....	13,560
# 95720	5 mm XC .....	13,560
# 95715	7 mm XC .....	13,560

A spin rate preamp and cable (shown above) is supplied with the bench spinner and included in the price. **A 40% discount will be given on a bench spinner ordered on the same purchase order with a corresponding probe.**

## Spin Rate Detection and Regulation

# 99560	<b>Spin Rate Detection Preamp / Power Supply 115 V</b>		<b>\$3270</b>
# 99455	<b>Spin Rate Detection Preamp / Power Supply 230 V</b>		<b>\$3270</b>
# 98930	Spin Rate Detection Preamp <b>Cable</b> for Optics		<b>\$106</b>
# 98931	Spin Rate Detection Preamp <b>Cable</b> for Tribo		<b>\$106</b>
# 69300	<b>Digital Frequency Counter</b>		<b>\$683</b>
# 91581	<b>Filtered Dual Air Regulator</b>		<b>\$3,327</b>

(US\$ –Foreign prices higher, plus taxes.)





# Temperature Control Accessories

## Extended Temperatures

Doty probes have variable temperature capabilities, and extended temperature options are also available.

### Wide Temperature range:

- 80°C to +120°C for NB Std VT
- 140°C to +170°C for WB Std VT
- 150 to +150°C NB XVT (extended VT)
- 150 to +250°C WB XVT (extended VT)
- 170°C LXVT (NB and WB low extended VT)

(with a Doty temperature controller). To extend the temperature range, we add extra insulation and thermal baffles, utilize special materials, add additional room air, and in some cases, add extra dewars to the probe.

## Probe Exhaust Dewar

A Probe Exhaust Dewar is required for sample temperatures above 160°C or below -100°C (except with cryogenic, high-temp, and a few other special probes) which have a different exhaust system. The exhaust dewar is included in extended VT options (described above) but may be ordered separately. Please supply the probe serial number when ordering to ensure that the proper dewar is supplied.

# 95980 Probe Exhaust Dewar ..... \$ 1010

## 50-Liter Liquid Nitrogen Dewar

This dewar is intended to be used with the Doty Cold-Gas System. (A Nitrogen Dewar already owned or purchased locally may be used if compatible with the cold-gas system, however specifications must match.)

## # 86020 50-Liter Liquid Nitrogen Dewar .... \$2140 Cold-Gas Supply Systems

Doty cold gas supplies include a heat exchanger with one, two or three intertwined pre-cooling coils; appropriate cooling coil sets; and one, two or three transfer lines to carry the cooled gas to the probe.

(The pre-cooler counterflow heat exchanger in the neck of the storage dewar greatly improves cooling efficiency – an important consideration for extended runs.)

The heat exchanger connects to the Doty probe with flexible, foam-insulated transfer lines with fully dewared quick connects. This system provides efficient cold gas supply for temperatures down to -150°C. The cold gas supply shown below is connected to a probe at one end and connected to a flow meter and regulated gas supply on the other. This system is designed to be used with the **standard 50-liter nitrogen dewar and probe exhaust dewar**, (listed in the left column) both of which **must be ordered separately**.

## # 99860 Single-Supply Cold-Gas System ... \$4,040

This cold-gas supply is for, standard speed or wideline probes and other single-supply applications. Also for OptiMAST™ cold zone cooling when VT gas is supplied by a separate system.

## # 95970 Dual-Supply Cold-Gas System ..... \$5,940

For spinning with separate bearing and drive or for other dual-supply applications. (Includes two intertwined pre-cooling coils, two cooling coil sets, and two transfer lines.)



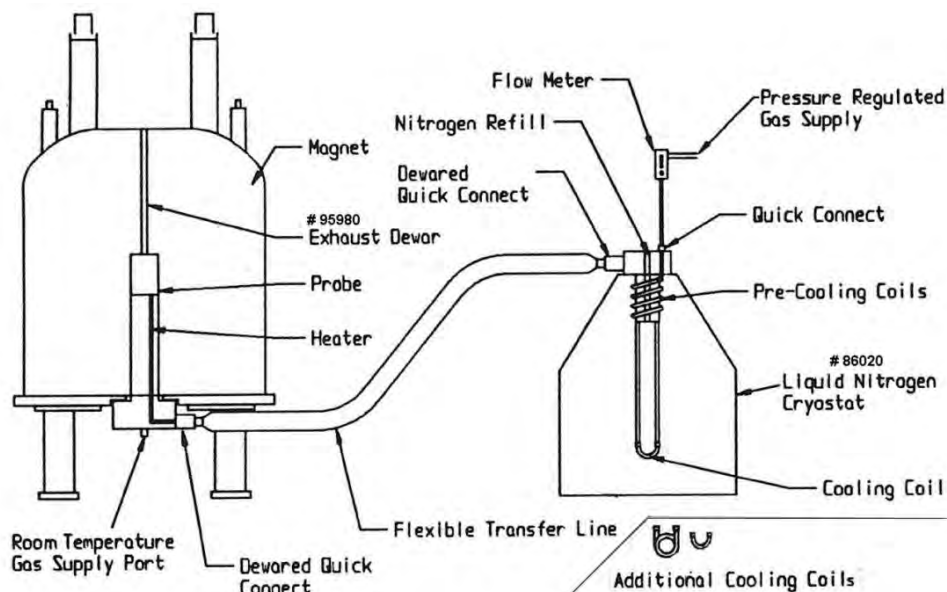



### Doty Cold Gas Supply – Installation Diagram (Single Supply Shown)



### Cold-Gas System





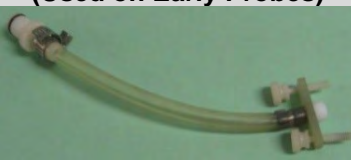

## General Accessories (Air Connectors, Paints, Glues)

Item			Part #	Price US\$
 <p><b># 96383</b> Brass Snap Tite Probe Air Connector with male quick connect</p>	<p><b>#96383-XVT</b> This XVT version is used for low temperature experiments – without a Doty cold gas VT system. Please supply the DotySerial number “DSI-__” when ordering.</p>			\$ 140
			<b># 96383-XVT</b>	(XVT) \$ 165
<p><b>Filtered Air Line with Female Quick Connect</b> These airlines are used for room temperature air cooling and other non-MAS probe air requirements.</p>  <p style="text-align: center;"><b># 96382</b></p>			<b># 96382</b>	\$ 82
<p><b>Filtered Air Line with Female Quick Connect – For MAS</b> These MAS air lines have internal channels that reduce turbulence at the drive and bearing inlets on MAS probes.</p>  <p style="text-align: center;"><b># 96382-MAS</b></p>			<b># 96382-MAS</b>	\$ 121
<p><b>Filtered Air Line with Male Quick Connect</b></p>  <p style="text-align: center;"><b># 90617</b></p>			<b># 90617</b>	\$ 82
<p><b>Quick Connect Set</b></p>  <p style="text-align: center;"><b># 96390</b></p>	<p><b>Female Quick Connect</b></p>  <p style="text-align: center;"><b># 58560</b></p>	<p><b>Male Quick Connect</b></p>  <p style="text-align: center;"><b># 58550</b></p>	<b># 96390</b>	\$ 66
			<b># 58560</b>	\$ 33
			<b># 58550</b>	\$ 33
<p><b>Ball and Clamp Probe Air Connector to male connect</b> (Used on Early Probes)</p> 			<b># 96381</b>	\$ 82
<b>Optical Rotor Paints</b>			<b># 96109</b>	\$ 95
<b>Glue for Caps for XVT</b>			<b># 99529</b>	\$ 66

(US\$ – Foreign prices higher, plus taxes.)

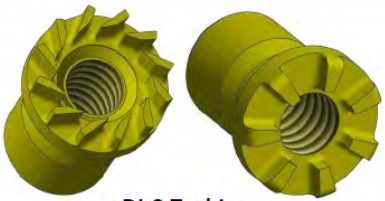

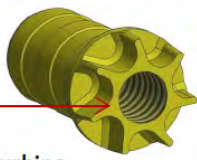
## Accessories For 3mm DI (Drop-in) Spinners

We have new, more robust turbines for DI-3 and DI-4 rotors. We are phasing these in beginning with Torlon and GFT. The new design includes modified turbine blades and a threaded hole with a different thread pitch thus necessitating a new Insertion and Removal Tool with matching thread. (New spacers will have the new thread as well.) We will continue to supply which-ever turbine puller you need (or both).

Item	Turbine and Spacer Insertion and Removal Tool	Thread
 <p style="text-align: center;">DI-3 Turbines</p>		<p><i>Part No: 06027</i></p> <p style="text-align: center;"><i>0-80 THREAD</i></p>
<p>Note how the turbine blades are connected to form a ring around the threaded hole.</p>  <p style="text-align: center;">New DI-3 Turbine</p>		<p><i>Part No: 03516</i></p> <p style="text-align: center;"><i>M1.2 – 25 THREAD</i></p>

➤ Teflon spacers are for highest homogeneity and rf field strength.

For material specifications: <http://dotynmr.com/download/Materials-and-Speeds-Data.pdf>





<b>DI-3 Rotor Length = 17.8 mm</b> Low density* Spinning max Thick Wall Rotor – Max. 28 kHz		<b>DI-3 Sample Volume:</b> Without spacers = 36.5 $\mu$ l With spacers = 13.6 $\mu$ l	<b>Front DI Turbine</b> 	<b>Rear DI Tip Cap</b> 
<b>Please note: Although the front turbine and rear tip cap are sold separately, a pair consisting of a front turbine and a rear tip cap, are needed for spinning.</b>				
Part #	Price	Description		Maximum Spin Speed*
<b>3 mm Rotors and Caps</b>				
46082	<b>\$760</b>	3 mm rotor – Silicon Nitride		28 kHz
46082-P	<b>840</b>	3 mm rotor – Silicon Nitride - <b>Painted</b> <i>For DI probes or Bench Spinners with optical detection</i>		28 kHz
<b>3 mm DI Turbines and 3 mm Tip Caps</b>				
46083	<b>\$88</b>	DI 3 front turbine cap – <b>GFT</b> (glass filled torlon)		<b>26 kHz</b>
46084	<b>88</b>	3 mm Rear Tip Cap – <b>GFT</b> (glass filled torlon)		28 kHz
46252	<b>88</b>	DI 3 front turbine cap – <b>Torlon</b> (can use with <b>GFT</b> Tip)		28 kHz
46072	<b>88</b>	3 mm Rear Tip Cap – <b>Torlon</b>		28 kHz
46077	<b>88</b>	DI3 front turbine cap – <b>Aurum</b>		18 kHz
46076	<b>88</b>	3 mm Rear Tip Cap – <b>Aurum</b>		18 kHz
46075	<b>88</b>	DI 3 mm front turbine cap – <b>Kel-F</b>		11 kHz
46074	<b>88</b>	3 mm Rear Tip Cap – <b>Kel-F</b>		11 kHz
46179	<b>30</b>	DI 3 mm <b>Teflon</b> Spacer	Restricts/centers the sample to within the coil region. <b>Two are required.</b>	
46168	<b>30</b>	DI 3 mm <b>Kel-F</b> Spacer		
Part #	Price	Cap Pullers and Accessories		
06027 or 03516	<b>\$88</b>	DI3 Turbine or Spacer Insertion and Removal Tool		
96195	<b>138</b>	Rotor Holder and Plungers – tools for tip cap and rear spacer removal		
96501	<b>200</b>	Sample Packing Set for 3 mm Rotors		

(US\$ – Foreign prices higher, plus taxes.)



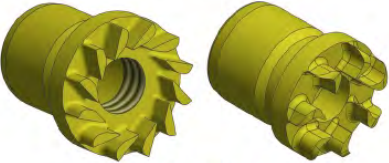

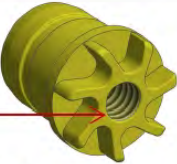
## Accessories For 4 mm DI (Drop-in) Spinners

We have new, more robust turbines for DI-3 and DI-4 rotors. We are phasing these in beginning with Torlon and GFT. The new design includes modified turbine blades and a threaded hole with a different thread pitch thus necessitating a new Insertion and Removal Tool with matching thread. (New spacers will have the new thread as well.) We will continue to supply which-ever turbine puller you need (or both).

Item	Turbine and Spacer Insertion and Removal Tool	Thread
 <p>DI-4 Turbines</p>		<p>Part No: 01003</p> <p>1-72 THREAD</p>
<p>Note how the turbine blades are connected to form a ring around the threaded hole.</p>  <p>New DI-4 Turbine</p>		<p>Part No: 06027</p> <p>0-80 THREAD</p>

➤ Thick wall rotors and Torlon caps are provided for **fastest spinning**. DI4 Thin wall rotors and caps are available for maximum signal to noise. The maximum speed of thin wall rotors is about 50% the maximum speed of thick wall rotors. Teflon, Kel-F or PPS spacers are provided for highest homogeneity and rf field strength.

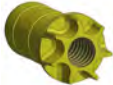
For material specifications: <http://dotynmr.com/download/Materials-and-Speeds-Data.pdf>

4 mm DI-4 Rotor Length = 24.95 mm		DI4 Sample Volume :	Front DI Turbine	Rear DI Tip Cap
Low density* Spinning max Thick Wall rotor – Max. 18 kHz		Thick Wall = 122 $\mu$ l, with Spacers = 60 $\mu$ l Thin Wall = 158 $\mu$ l, with Spacers = 77 $\mu$ l		
Please note: Although the front turbine and rear tip cap are sold separately, a pair consisting of a front turbine and a rear tip cap are needed for spinning.				
DI4 #	Price	Description	Maximum SpinSpeed*	
<b>Thick Wall Rotors and Caps</b>			<b>4 mm</b>	
45127	\$712	DI 4mm Thick Wall Rotor – Silicon Nitride	18 kHz	
45127-P	790	DI 4mm Thick Wall Rotor – Silicon Nitride - <b>Painted</b> *	18 kHz	
45129	\$82	DI 4mm Front Turbine Cap for Thick Wall – <b>GFT</b> (glass filled torlon)	18 kHz	
46136	82	DI 4mm Rear Tip Cap for Thick Wall – <b>GFT</b> (glass filled torlon)	18 kHz	
46142	82	DI 4mm Front Turbine Cap for Thick Wall – <b>Torlon</b>	18 kHz	
46140	82	DI 4mm Rear Tip Cap for Thick Wall – <b>Torlon</b>	18 kHz	
46142-A	82	DI 4mm Front Turbine Cap for Thick Wall – <b>Aurum</b>	15 kHz	
46140-A	82	DI 4mm Rear Tip Cap for Thick Wall – <b>Aurum</b>	15 kHz	
45130	82	DI 4mm Front Turbine Cap for Thick Wall – <b>Kel-F</b>	9 kHz	
46137	82	DI 4mm Rear Tip Cap for Thick Wall – <b>Kel-F</b>	9 kHz	
45137	30	DI 4mm Spacer for Thick Wall Rotors – <b>Teflon</b>	Restricts/centers the sample to within the coil region). <b>Two are required.</b>	
46206	30	D 4mm Spacer for Thick Wall Rotors – <b>Kel-F</b>		
46401	30	D 4mm Spacer for Thick Wall Rotors – <b>PPS</b>		

\* Painted rotors are for probes with optical detection

(US\$ – Foreign prices higher, plus taxes.)

4mm DI Continued...



## Accessories For 4 mm DI (Drop-in) Spinners

DI4 #	Price	DI4 Thin Wall Rotors and Caps	Maximum Spin Speed
03136	<b>\$712</b>	DI 4mm Thin Wall Rotor – Silicon Nitride	12 kHz
03136-P	<b>790</b>	DI 4mm Thin Wall Rotor – Silicon Nitride - <b>Painted</b> <b>Painted rotors are for probes with optical detection</b>	12 kHz
45128	<b>648</b>	DI 4mm Thin Wall Rotor – Zirconia (Use Only With Probe with Optical detection)	10 kHz
45131	<b>82</b>	DI 4mm Front Turbine Cap for Thin Wall – <b>GFT</b> (glass filled torlon)	12 kHz
46138	<b>82</b>	DI 4mm Rear Tip Cap for Thin Wall – <b>GFT</b> (glass filled torlon)	12 kHz
46141	<b>82</b>	DI 4mm Front Turbine Cap for Thin Wall – <b>Torlon</b>	12 kHz
46169	<b>82</b>	DI 4mm Rear Tip Cap for Thin Wall – <b>Torlon</b>	12 kHz
46141-A	<b>82</b>	DI 4mm Front Turbine Cap for Thin Wall – <b>Aurum</b>	12 kHz
46169-A	<b>82</b>	DI 4mm Rear Tip Cap for Thin Wall – <b>Aurum</b>	12 kHz
45132	<b>82</b>	DI 4mm Front Turbine Cap for Thin Wall – <b>Kel-F</b>	9 kHz
46139	<b>82</b>	DI 4mm Rear Tip Cap for Thin Wall – <b>Kel-F</b>	9 kHz
45138	<b>30</b>	DI 4mm Spacer for Thin Wall Rotors – <b>Teflon</b>	Restricts/centers the sample to within the coil region). <b>Two are required.</b>
46207	<b>30</b>	DI 4mm Spacer for Thin Wall Rotors – <b>Kel-F</b>	
46402	<b>30</b>	DI 4mm Spacer for Thin Wall Rotors – <b>PPS</b>	
DI4 #	Price	Cap Pullers and Accessories	
01003 or 06027	<b>\$82</b>	DI4 Turbine or Spacer Insertion and Removal Tool (Used for both turbine caps and spacers - since 10/2012)	
96188	<b>130</b>	Rotor Holder and Plungers – tools for tip cap and rear spacer removal	
99683	<b>190</b>	Sample Packing Set For Thick Wall DI 4 Rotors	
99682	<b>190</b>	Sample Packing Set For Thin Wall DI 4 Rotors	



### DI-4 Sealing Cells for Liquids and Semi-Solids

Sealing cells are for use inside DI thin-walled ceramic rotors. The plastic cells are available in Kel-F with teflon plugs for proton NMR, or in ultem with polyvinyl-chloride (PVC) plugs for fluorine NMR.

All cells are suitable for long-term sample storage without loss. They may be used with all common solvents, including acetone, alcohols, benzene, DMSO, ethers, methylene chloride, strong bases, and most strong acids – as long as the sample density does not exceed the density of the plug (2.2 g/cm<sup>3</sup> for teflon, 1.4 g/cm<sup>3</sup> for PVC).

#### 4 mm DI4 Sealing Cells. (For thin wall rotors )

Kel-F cells with teflon plugs or Ultem cells with PVC plugs.

	Kel-F	Ultem	Sample	Price
	Part #	Part #	Volume	_____
DI4	95142	95143	50 µL .....	\$52
DI4	95141	95139	20 µL .....	52

#### DI 4 Rotor with sealing cell in place

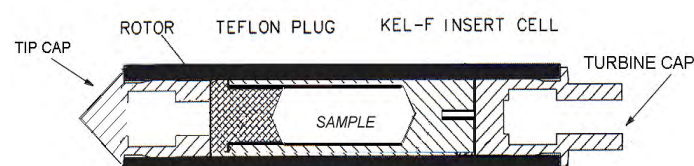

(US\$ –Foreign prices higher, plus taxes.)



## Sealing Cells for Liquids and Semi-Solids For XC and DI Spinners

All sealing cells are for use inside XC and DI thin-walled ceramic rotors. The plastic cells are available in Kel-F with teflon plugs for proton NMR or in Ultem with polyvinyl-chloride (PVC) plugs for fluorine NMR.

All cells are suitable for long-term sample storage without loss. They may be used with all common solvents, including acetone, alcohols, benzene, DMSO, ethers, methylene chloride, strong bases, and most strong acids – as long as the sample density does not exceed the density of the plug (2.2 g/cm<sup>3</sup> for teflon, 1.4 g/cm<sup>3</sup> for PVC).

**For material specifications:** <http://dotynmr.com/download/Materials-and-Speeds-Data.pdf>

### DI4

**Note:** DI rotors use a rear tip cap and a front turbine cap.

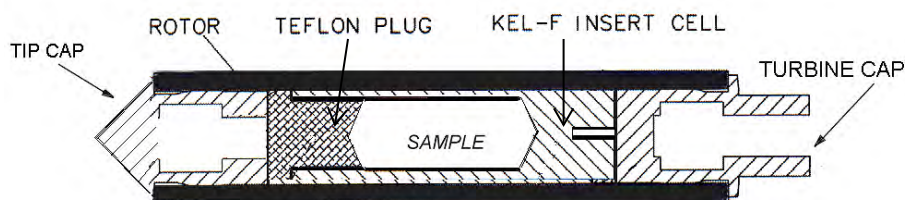

**4 mm DI4 Sealing Cells.** (For thin wall rotors ) Kel-F cells with teflon plugs or Ultem cells with PVC plugs. Use with thin-walled rotors and caps.

Kel-F Part #	Ultem Part #	Sample Volume	Price
95142	95143	50 μL .....	\$52
95141	95139	20 μL .....	\$52

### XC4 and XC5

**Note:** XC rotors use a front turbine cap and rear turbine cap.

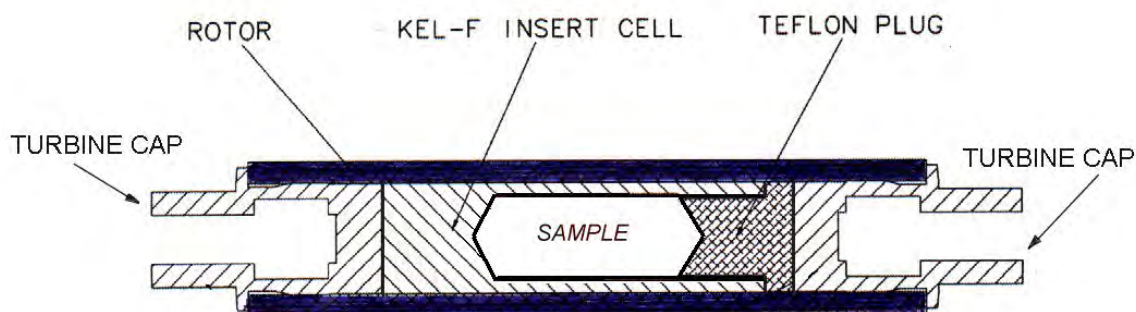

**4 mm XC4 Sealing Cells.** (For thin wall rotors ) Kel-F cells with teflon plugs or Ultem cells with PVC plugs. Use with thin-walled rotors and short XC caps.

Kel-F Part #	Ultem Part #	Sample Volume	Price
XC4 99694	99691	40 μL.....	\$52
XC4 99693	99689	20 μL .....	52

**5 mm XC5 Sealing Cells.** (For thin wall rotors ) Kel-F cells with teflon plugs or Ultem cells with PVC plugs. Use with thin-walled rotors and short XC caps.

Kel-F Part #	Ultem Part #	Sample Volume	Price
XC5 99801	99793	75 μL .....	\$52
XC5 99799	99792	50 μL .....	52

**US\$ - Forien prices higher, plus taxes.**

## XC Rotors



### 4 mm XC4 Length =20.95 mm

Sample – 66 µL to 124 µL  
Low density\* Spinning maximum | kHz |

# 43255	Silicon Nitride XC Thick Wall Rotor	22	\$654
# 43483	Zirconia XC Thin Wall Rotor	11	654

### 5 mm XC5 Length =22.25 mm

Sample – 82 µL to 201 µL  
Low density\* Spinning maximum | kHz |

# 13265	Silicon Nitride XC Thick Wall Rotor	18	\$654
# 13267	Silicon Nitride XC Thin Wall Rotor	16	660
#13268	Zirconia XC Thin Wall Rotor	9	654

### 7 mm XC7 Length =29.00 mm

Sample – 241 µL to 564 µL  
Low density\* Spinning maximum | kHz |

# 43526	Silicon Nitride XC Thick Wall Rotor	12	\$654
# 43528	Zirconia XC Thick Wall Rotor	8	495
# 43527	Silicon Nitride XC Thin Wall Rotor	11	715
# 43529	Zirconia XC Thin Wall Rotor	7	550

### 10 mm XC10 Length =35.00 mm

Sample volume – .6 mL to 1.10 mL  
Low density\* Spinning maximum | kHz |

# 44265	Zirconia XC Thick Wall Rotor	8.5	\$875
# 44266	Zirconia XC Thin Wall Rotor	4.5	918

### 5 mm SuperSonic (SS) Length =14.93 mm

Sample volume – 56 µL to 110 µL  
Low density\* Spinning maximum | kHz |

# 13251	Silicon Nitride SS Thick Wall Rotor	18	\$654
# 42388	Silicon Nitride SS Thin Wall Rotor	16	660
# 42396	Zirconia SS Thin Wall Rotor	9	654

### 7 mm SuperSonic (SS) Length =22.10 mm

Sample volume – 215 µL to 360 µL  
Low density\* Spinning maximum | kHz |

# 13857	Silicon Nitride SS Thick Wall Rotor	12	\$605
# 13858	Zirconia SS Thick Wall Rotor	8	495
# 13859	Silicon Nitride SS Thin Wall Rotor	11	715
# 13861	Zirconia SS Thin Wall Rotor	7	550

### 10 mm SuperSonic (SS) Length =27.50 mm

Sample volume – .6 mL to 1.10 mL  
Low density\* Spinning maximum | kHz |

# 42113	Silicon Nitride SS Thick Wall Rotor	8.5	\$ 864
# 42138	Zirconia SS Thick Wall Rotor	6	864
# 42193	Silicon Nitride SS Thin Wall Rotor	8	918
# 42173	Zirconia SS Thin Wall Rotor	4.5	918

- **For material specifications:** <http://dotynmr.com/download/Materials-and-Speeds-Data.pdf>
- Thick wall rotors and GFT or Turlon caps are provided for **fastest spinning** and ease in packing. Thin wall rotors and caps are available for maximum signal to noise. The maximum speed of thin wall rotors is about 50% the speed of thick wall rotors. Long caps are provided for highest homogeneity and rf field strength.
- **For XC probes**, (beginning in 2000) **XC "Slow MAS"** is provided for stable very slow spinning of tissues, liquids, and CC by a change in "nozzle caps" only. **The same turbine caps are used.** All choices of XC rotors and caps may be used with slow spin nozzle caps. A 50% reduction in maximum spinning speeds should be expected for each type. See page 4 for more specifications.

XC, SuperSonic, DI, High Speed, and Standard accessories are **not** interchangeable unless specified. If unsure about correct supplies, contact us with the probe DSI-serial number and we can help.

**(US\$ – Foreign prices higher, plus taxes)**



## Accessories for XC

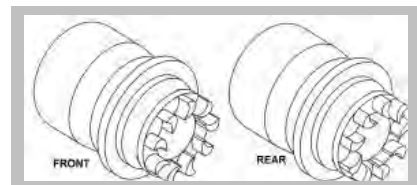

**SuperSonic (SS) and XC rotors and caps are different.**  
**Check the rotor length to be sure you order the correct parts.**

**For material specifications:** <http://dotynmr.com/download/Materials-and-Speeds-Data.pdf>

XC4	XC5	XC7	If unsure, check the rotor length (mm) listed on the left to confirm that you need XC parts.	Price
4 mm Rotor Length = 20.95	5 mm Rotor Length = 22.25	7 mm Rotor Length = 29.00		
Part #	Part #	Part #	Description	
<b>Caps for THICK Wall Rotors – fastest spinning</b>				
99705	96432	96462	<b>XC Kel-F Short</b> Thick Cap Pair	<b>\$184</b>
99702	99844	99637	<b>XC Kel-F Long</b> Thick Cap Pair	<b>184</b>
99684	99822	99816	<b>XC GFT Short</b> Thick Cap Pair, <b>GFT</b> (glass filled torlon)	<b>210</b>
99685	99821		<b>XC GFT Long</b> Thick Cap Pair, <b>GFT</b> (glass filled torlon)	<b>210</b>
96431	96457	96466	<b>XC Torlon (or Aurum *) Short</b> Thick Cap Pair	<b>210</b>
96433	99839	-----	<b>XC Torlon (or Aurum *) Long</b> Thick Cap Pair	<b>210</b>
----	----	96468	XC/SS Kel-F <b>O-Ring</b> Cap Pair	<b>298</b>
----	----	96469	XC/SS Aurum <b>O-Ring</b> Cap Pair	<b>298</b>
<b>Caps for THIN Wall Rotors</b>				
99699	96434	96464	<b>XC Kel-F Short</b> Thin Cap Pair	<b>\$184</b>
99697	99835	99635	<b>XC Kel-F Long</b> Thin Cap Pair	<b>184</b>
99686	99824	99817	<b>XC GFT Short</b> Thin Cap Pair, <b>GFT</b> (glass filled torlon)	<b>210</b>
99687	99823	-----	<b>XC GFT Long</b> Thin Cap Pair, <b>GFT</b> (glass filled torlon)	<b>210</b>
99722	99834	96465	<b>XC Torlon (or Aurum *) Short</b> Thin Cap Pair	<b>210</b>
99723	99833	99636	<b>XC Torlon (or Aurum *) Long</b> Thin Cap Pair	<b>210</b>
<b>Cap Pullers and Accessories</b>				
96182	96182	96360	Puller for Turbine Caps	<b>\$248</b>
----	----	96170	Threaded Cap Puller for O-ring Caps	<b>130</b>
01026	06019	06023	Rotor Holder – use with plungers below	<b>52</b>
01028	06021	43761	Plunger - thick wall- to push out caps or sealing cells	<b>42</b>
01029	06022	42039	Plunger - thin wall- to push out caps or sealing cells	<b>42</b>
99683	96511	96113	<b>XC Sample Packing Set for Thick Wall Rotors</b>	<b>\$190</b>
99682	96513	96114	<b>XC Sample Packing Set for Thin Wall Rotors</b>	<b>190</b>

### MAS Turbine Cap Spinning Speeds

#### Maximum Spinning Speeds (kHz) For Caps at Room Temperature

Cap Style	4 mm XC	5-mm XC	7-mm XC
<b>Kel-F</b>	<b>11</b>	<b>10</b>	<b>7</b>
<b>Caps with o-rings</b>	-----	-----	<b>7</b>
<b>Aurum</b>	<b>22</b>	<b>18</b>	<b>12</b>
<b>Torlon or GFT</b>	<b>22</b>	<b>18</b>	<b>12</b>

This chart represents only material characteristics for caps. Check the Probe and Rotor Specifications.

\* Torlon has very similar NMR properties and will be substituted if Aurum is not available.

**(US\$ – Foreign prices higher, plus taxes)**



## Accessories Supersonic (SS)

**SuperSonic (SS) and XC rotors and caps are different. Check the rotor length to be sure you order the correct parts.**

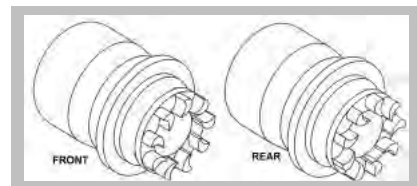

**For material specifications:** <http://dotynmr.com/download/Materials-and-Speeds-Data.pdf>

SS 5 mm	SS 7 mm	If unsure, check the rotor length (mm) listed on the left to confirm that you need SS parts.	
5 mm Rotor Length = 14.93 mm	7 mm Rotor Length = 22.10 mm		
Part #	Part #	Description	Price
<b>Caps for THICK Wall Rotors – fastest spinning</b>			
96432-SS	96462	<b>SS Kel-F Short Thick Cap Pair</b>	<b>\$184</b>
99822-SS	99816	<b>SS GFT Short Thick Cap Pair, GFT (glass filled torlon)</b>	<b>210</b>
96457-SS	96466	<b>SS Torlon (or Aurum*) Short Thick Cap Pair</b>	<b>210</b>
-----	96468	SS Kel-F <b>O-Ring Cap Pair</b>	<b>298</b>
-----	96469	SS Aurum <b>O-Ring Cap Pair</b>	<b>298</b>
<b>Caps for THIN Wall Rotors</b>			
96434-SS	96464	<b>SS Kel-F Short Thin Cap Pair</b>	<b>\$184</b>
99824-SS	99817	<b>SS GFT Short Thin Cap Pair, GFT (glass filled torlon)</b>	<b>210</b>
99834-SS	96465	<b>SS Torlon (or Aurum*) Short Thin Cap Pair</b>	<b>210</b>
96472-SS	90613	<b>SS Torlon Long Thin Cap Pair</b>	<b>210</b>
<b>Cap Pullers and Accessories</b>			
96182	96360	Puller for Turbine Caps	<b>\$248</b>
-----	96170	Threaded Cap Puller for O-ring Caps	<b>130</b>
06019	06023	Rotor Holder – use with plungers below	<b>52</b>
06021	43761	Plunger - thick wall- to push out caps or sealing cells	<b>42</b>
06022	42039	Plunger - thin wall- to push out caps or sealing cells	<b>42</b>
96059	96510	<b>SS Sample Packing Set for Thick Wall Rotors</b>	<b>190</b>
96515	96517	<b>SS Sample Packing Set for Thin Wall Rotors</b>	<b>190</b>

### MAS Turbine Cap Spinning Speeds

**Maximum Spinning Speeds (kHz) For Caps at Room Temperature**

Cap Style	5-mm SuperSonic	7-mm SuperSonic
Kel-F	10	7
Caps with o-rings	-----	7
Aurum	18	12
Torlon or GFT	18	12

This chart represents only material characteristics for caps.  
Check the Probe and Rotor Specifications.

\* Torlon has very similar NMR properties and will be substituted if Aurum is not available.

**(US\$ – Foreign prices higher, plus taxes.)**



## Accessories for 5 mm and 7 mm High-Speed MAS

For material specifications: <http://dotynmr.com/download/Materials-and-Speeds-Data.pdf>

Thick wall rotors are provided for fastest spinning and ease in packing. Thin wall rotors and short caps provide maximum signal to noise. Long caps are provided for highest homogeneity and rf field strength or for limited samples.

- High Speed, SuperSonic, XC, DI, and Standard accessories are **not** interchangeable unless specified. If unsure about correct supplies, contact us with the probe DSI-serial number and we can help. Note: SuperSonic rotors may be used in High Speed spinners, but High Speed rotors will not work in SuperSonic spinners.

### 5 mm High Speed

**Rotor length= 14.93 mm**

Spinning speed max. 14 kHz,

Sample volume – 57 µL to 95 µL

Turbine Cap Design



FRONT CAP REAR CAP

### 7 mm High Speed

**Rotor length= 22.10 mm**

Spinning speed max. 9 kHz,

Sample volume – 240 µL to 370 µL

Part #	Price	Description	Part #	Price
<b>Thick Wall Rotors</b>				
13260	\$ 605	Silicon Nitride Rotor	13860	\$ 605
13280	275	Macor Rotor	13880	275
<b>End Caps for Thick Wall Zirconia and Silicon Nitride Rotors</b>				
97780	\$120	Kel-F Short Cap Pair	97830	\$120
97810	120	Kel-F Long Cap Pair	97860	120
97790	132	Aurum (or Torlon*) Short Cap Pair	97840	132
97820	132	Aurum Long Cap Pair	97870	132
96446	230	Kel-F O-Ring Cap Pair**	96447	230
96900	230	Aurum O-Ring Cap Pair**	96448	230
<b>End Caps for Macor Rotors</b>				
13291	\$116	Kel-F O-Ring Rear Turbine for Macor Rotor**	13531	\$116
13680	116	Aurum O-Ring Rear Turbine for Macor Rotor**	13533	116
<b>Thin Wall Rotors</b>				
42384	\$715	Silicon Nitride Rotor	13856	\$715
42238	605	Zirconia Rotor	42237	605
<b>End Caps for Thin Wall Zirconia and Silicon Nitride Rotors</b>				
96485	\$120	Kel-F Short Cap Pair	96481	\$120
96486	120	Kel-F Long Cap Pair	96482	120
96487	132	Aurum Short Cap Pair	96483	132
96488	132	Aurum Long Cap Pair	96484	132
<b>Cap Pullers and Accessories</b>				
94810	\$253	Kel-F Front Housing Cap	94790	\$253
94820	341	Kel-F Back Housing Cap	94800	341
7130	33	Kel-F Housing Thumb Screws (priced per pair)	7130	33
96360	192	Puller for Long and Short Kel-F, Vespel, Torlon or Aurum Caps	96310	192
96190	120	(5 mm) Black Threaded End-Cap Puller for O-ring Caps (4-48 Thread)	----	----
----	----	(7 mm) Gray Threaded End-Cap Puller for O-ring Caps (6-40 Thread)	96180	120
96530	176	Sample Packing Tool Set for Thick Wall	96540	176
96514	176	Sample Packing Tool Set for Thin Wall	96516	176

\* Torlon has very similar NMR properties and may be substituted if Aurum is not available.

**\*\* Specify on the order.** – One can insert o-ring turbines by twisting them in by hand. Or, O-ring turbine caps can be ordered with threaded holes for insertion and removal with a threaded cap puller. Front turbine caps can also be ordered with an axial out-gassing hole for high temp work or to remove air bubbles. O-ring caps can be used for liquids, for sealing, or for VT.

**(US\$ – Foreign prices higher, plus taxes.)**



## Accessories For 5 mm and 7 mm Standard MAS

Short caps are provided for maximum signal to noise. Long caps are provided for highest homogeneity and rf field strength. Long caps are also for limited samples.

**For material specifications:** <http://dotynmr.com/download/Materials-and-Speeds-Data.pdf>

- Standard, High Speed, SuperSonic, XC, and DI and accessories are **not** interchangeable. If unsure about correct supplies, contact us with the probe DSI-serial number and we can help.

### 5 mm Standard

**Rotor length=13.08 mm**

Spinning speed max. 9 kHz,

Sample volume – 60 µL to 110 µL

### Turbine Cap Design



FRONT CAP REAR CAP

### 7 mm Standard

**Rotor length=18.31 mm**

Spinning speed max. 6 kHz, Sam-

ple volume – 200 µL to 350 µL

Part #	Price	Description	Part #	Price
<b>Rotors</b>				
5511	\$660	Silicon Nitride Rotor	7511	\$660
5520	362	Zirconia Rotor	7520	362
5900	275	Macor Rotor	7900	275
<b>End Caps for Zirconia and Silicon Nitride Rotors</b>				
97650	\$88	Kel-F Short Cap Pair	97500	\$88
97660	88	Kel-F Long Cap Pair	97510	88
96518	55	Kel-F Spherical Sample Cell Insert Pair for CRAMPS Experiments (Use with long Kel-F caps)	----	----
97680	100	Aurum Short Cap Pair	97530	100
97690	100	Aurum Long Cap Pair	97540	100
96443	170	Kel-F O-Ring Cap Pair*	96435	170
97940	170	Aurum O-Ring Cap Pair*	96445	170
<b>End Caps for Macor Rotors</b>				
5980	\$50	Kel-F Plug Cap for Macor Rotor	----	----
5990	50	Teflon Plug Cap for Macor Rotor	----	----
5572	116	Kel-F O-Ring Plug Cap for Macor Rotor*	7541	\$116
5573	116	Aurum O-Ring Plug Cap for Macor Rotor*	7542	116
<b>Cap Pullers and Accessories</b>				
5170	\$170	Kel-F Front Housing Cap	7170	\$170
7130	33	Kel-F Housing Thumb Screws (priced per pair)	7130	33
96220	192	Puller for Long and Short Kel-F, Vespel, Torlon or Aurum Caps	96240	192
96170	120	<b>5 mm</b> Blue Threaded End Cap Puller for 5 mm O-ring Caps (2-4 mm Thread)	----	----
----	----	<b>7 mm</b> Red Threaded End-Cap Puller for 7 mm O-ring Caps, (5-44 Thread)	96250	120
----	----	<b>For 7 mm Macor caps for Macor rotors</b> - Black Threaded Cap Puller (4-48 Thread)	96190	120
96500	176	Sample Packing Tool Set for Silicon Nitride and Zirconia Rotors	96520	176
4710	55	Packing Tamp for Caps with Axial Screws	4700	55

\* **Specify on the order.** – Some prefer to insert o-ring turbines by twisting them in by hand. However, o-ring turbine caps can be ordered **with threaded holes** to be inserted and removed with the threaded cap puller. (Plug caps must be removed with the threaded tool.) Front turbine caps can also be ordered **with an axial out-gassing hole** for higher temperature work or to remove air bubbles. *O-ring caps can be used for liquids, for sealing, or for some VT.*

(US\$ – Foreign prices higher, plus taxes)



## Doty Spinner Assembly Materials

Doty spinners utilize super-precision, wear-resistant ceramic stators of silicon nitride or zirconia. MAS spinner materials must be chosen carefully based on background signals and temperature ranges. Ceramic rotors and plastic caps of various materials are available to provide fast spinning with limited background problems.

Material	Material Specifications			Turbine Cap Specifications	
	Upper Temp	Major Constituents	Minor Elements	Recommended Use	Cap VT Operation Range
Silicon Nitride	1400°C *	98% Si <sub>3</sub> N <sub>4</sub>	2% Y <sub>2</sub> O <sub>3</sub> , .005 Al		
Zirconia	650°C *	94 ZrO <sub>2</sub> , 4 Y <sub>2</sub> O <sub>3</sub>	Hf, 0.3% Si, .02 Al		
Macor	650°C *	Al, Si, O, B, K	2% F, Mg		
Kel-F	130°C *	F, C, Cl		proton & carbon studies	-20°C to 70°C.
GF Torlon (30% Glass)	260°C*	H, C, O, Si	Ti, N, F	fast spinning, wide temperature range, wear resistant	-120°C to 160°C (glued in with epoxy -170°C to 250°C)
Glass Fibers in GFT		SiO <sub>2</sub>	CaO, MgO, Al <sub>2</sub> O <sub>3</sub> , B <sub>2</sub> O <sub>3</sub>		
Torlon	260°C*	H, C, O	Ti, N	fast spinning and low <sup>29</sup> Si or low <sup>19</sup> F	-30°C to 80°C
Aurum	240°C *	H, C, O	N	fast spinning and low <sup>29</sup> Si or low <sup>19</sup> F	-30°C to 80°C
Vespel	300°C *	H, C, O	N	special extended VT caps	-270°C to 240°C

\* **Note:** This chart represents only material characteristics. Check the Probe Specifications.

**Non-spinning parts can tolerate different temperatures than turbine caps spinning on rotors.**

### Spinner Assembly Materials – Plastics

**GFT (Glass-fiber-reinforced Torlon):** Glass-fiber-reinforced Torlon grade 5030 will be used for some MAS turbine caps for greatly improved VT performance and all-around better reliability and performance. This new material stands out from the rest with respect to isotropic thermal expansion (only 16E-6/°C), tensile strength at 200°C (120 MPa), and heat distortion temperature (282°C). It also has rather low moisture absorption, high wear resistance, and high impact strength. These caps are the most wear resistant and have the widest temperature range. GFT is not recommended for proton studies, or for some silicon and some carbon studies. Caps may be used from -120°C to 160°C repeatedly (or when glued in with epoxy from -170°C to 250°C).

**Torlon:** Torlon is used for fastest spinning of DI3 turbines. This green thermoplastic polyamide-imide, has exceptional chemical resistance. Caps may be used from -30°C to 80°C repeatedly. *The caps may be used once to higher temperatures but they will be too loose after that.* (In non-spinning parts of the spinner assembly, the upper temperature limit is 260°C.) Torlon is not recommended for proton studies or for some carbon studies. As Torlon has a relatively high moisture absorption rate .03%/24hours, it may be periodically necessary to bake out the turbine caps or tip caps at 50°C for one hour. This is necessary if the caps become too tight. (The opposite condition is much less likely. However, if one is in a very arid area or operating in a low moisture environment, the caps may have to be soaked in a liquid too make them tighter.)

**Kel-F:** A translucent white plastic, Kel-F is background free for all nuclei except F, Cl, and C. Kel-F is also excellent for carbon studies since the strong fluorine coupling effectively broadens the Kel-F carbon signal, and there are no protons to cross polarize. Kel-F is not as strong or wear resistant as the other cap materials and is thus restricted to lower spinning speeds. Kel-F turbine caps can be used at temperatures from -20°C to 70°C. (In non-spinning parts of the spinner assembly, the upper temperature limit is 130°C.)

**Aurum\*:** This material is no longer available in appropriate form for our manufacturing, so Aurum is being replaced by Torlon. Aurum will be supplied if requested and is available, but supplies are severely limited.

This dark brown to black thermoplastic polyimide has excellent dielectric properties. Aurum can be used for low silicon applications when fast spinning is desired. Aurum is supplied for some probes designed for fluorine studies and other applications where carbon is not a problem. Turbine caps may be used from -30°C to 80°C repeatedly. (In non-spinning parts of the spinner assembly, the upper temperature limit is 240°C.)





**Vespel:** This brown plastic is used for some extended temperature caps and for non-spinning spinner assembly parts that will reach temperatures over 200°C. Vespel is not recommended for proton studies or for some carbon studies.

## O-Ring Caps

### *For wet samples, air sensitive samples, and variable temperatures*

**O-ring Caps:** Turbines and plug caps with dual Viton o-ring seals are available for Macor, silicon nitride, and zirconia rotors. Macor rotors, (available only for standard and high speed probes) are recommended for wet samples, air sensitive samples, and temperatures from -60°C to 250°C. A single (rear) cap with o-rings is used with a Macor rotor. However, if faster spinning is critical, VT and air-sensitive experiments can be done in silicon nitride or zirconia rotors using o-ring-sealed cap pairs. O-ring turbine caps are normally inserted and removed by hand. Turbines with threaded holes can be ordered with a threaded insertion tool for use when loading samples in a glove box (and to remove standard speed plug caps.) Caps can be ordered with axial out-gassing holes for higher temperature work or to remove air bubbles.

**Although the supersonic o-ring caps can be used for air sensitive samples in XC5 and XC7 probes, XC sealing cells are usually preferred.**

- **Kel-F O-ring Caps:** ..... Temperature range with o-rings: -45°C to 80°C.
- **Aurum or Torlon O-ring Caps:** ..... Temperature range with o-rings: -45°C to 120°C.

## Extended Temperature Caps

- **DI, XC4 and XC5 probes (and most supersonic) use Glass-fiber-reinforced Torlon (GFT) – glued in.**  
GFT – **if glued in:** ..... Temperature range: -170°C to 250°C

\* **Torlon is replacing aurum for most parts, depending on availability.** Torlon can be used as a substitute for aurum as the NMR characteristics are similar.

---

## Spinner Assembly Materials – Ceramics

**Silicon Nitride:** With a density of about 3.18 g/cm<sup>3</sup> and a (working) tensile strength of 700 MPa, silicon nitride has the highest strength-to-weight ratio of any ceramic available today. Its hardness and toughness make it very difficult to grind, but it has the lowest dielectric loss and lowest permittivity of any engineering ceramic, making it the best choice for high frequencies. A HIPed (Hot Isostatic Pressed) variety is available with improved strength and dielectric properties. Its superior electrical properties make it the preferred material for most applications (often, even for silicon and nitrogen), because of silicon's long T<sub>1</sub> and nitrogen's low natural abundance. The color is black. The only additive or impurity greater than 200 ppm in this new material is yttria. Silicon nitride stators, housings, and rotors are available in all sizes. This material is required for fastest spinning.

**Zirconia:** This yttria-stabilized, high-purity material is glossy white and has a density of about 6 g/cm<sup>3</sup> and a (working) tensile strength of 700 MPa. Alumina content can be kept below 100 ppm. Zirconia is less expensive than silicon nitride, but the safe spinning speed for zirconia rotors is lower than that of silicon nitride.

**Macor:** This white, machineable, boro-silicate glass-ceramic is loaded with synthetic mica to inhibit crack propagation. It is easily machined with conventional tooling. Macor housings may be provided for carbon and proton studies at temperatures over 160°C in our standard speed MAS probes. Macor is useable up to 650°C, but it has very poor thermal shock tolerance. Macor rotors are only available for the high speed and standard spinners. Macor rotors are made with a thicker wall and are machined with an integral turbine at one end. Standard speed rotors require a plug-cap at the open end, while high-speed rotors require a rear turbine. Macor rotors are recommended for wet samples, air-sensitive samples, and temperatures from -150°C to 250°C. Major constituents: Al, Si, O, B, K, F.

**Boron Nitride:** Boron Nitride is not used in Doty probes. However, the hexagonal hot-pressed variety, with 6% calcium borate binder, is easily machineable and is used for disposable inserts for the high-temperature ceramic rotors for the Doty high temperature probe (700°C). The material is soft enough to scratch easily and may absorb up to 1% moisture.

See 3 mm next page.

Maximum <b>PROBE</b> Speeds (kHz)	
DI 4	18
XC4	22
XC5	18
5 SS	18
5 HS	14
5 Std	9

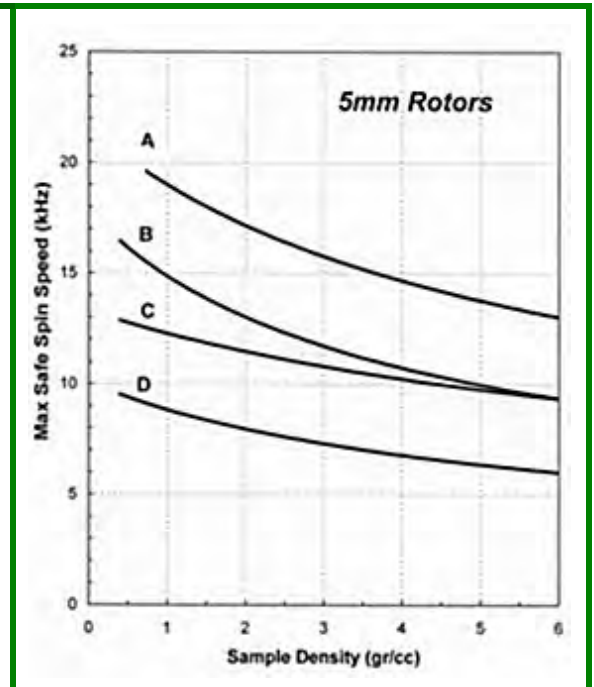
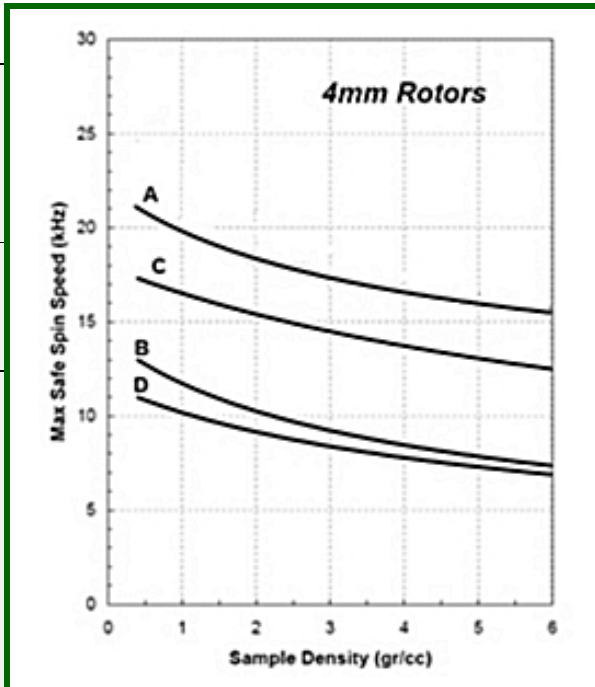

A - Si<sub>3</sub>N<sub>4</sub> Thick Wall | B - Si<sub>3</sub>N<sub>4</sub> Thin Wall | C - Zr Thick Wall | D - Zr Thin Wall

Maximum <b>PROBE</b> Speeds (kHz)	
XC7	12
7 SS	12
7 HS	9
7 Std	6
XC10	8.5
10 SS	8.5

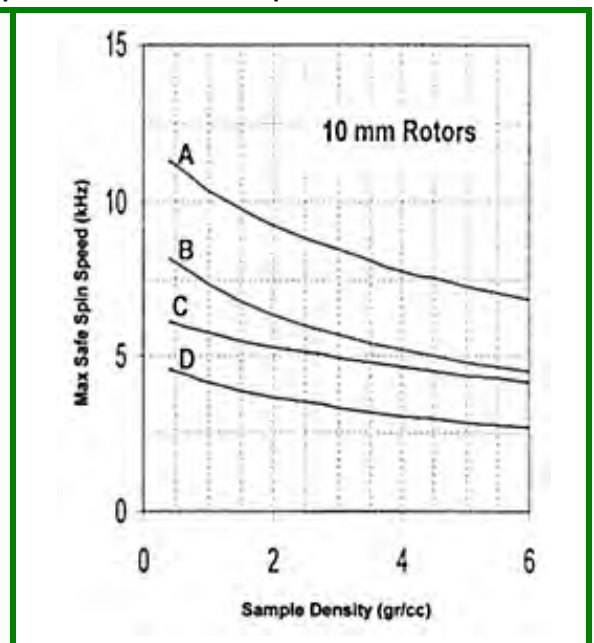
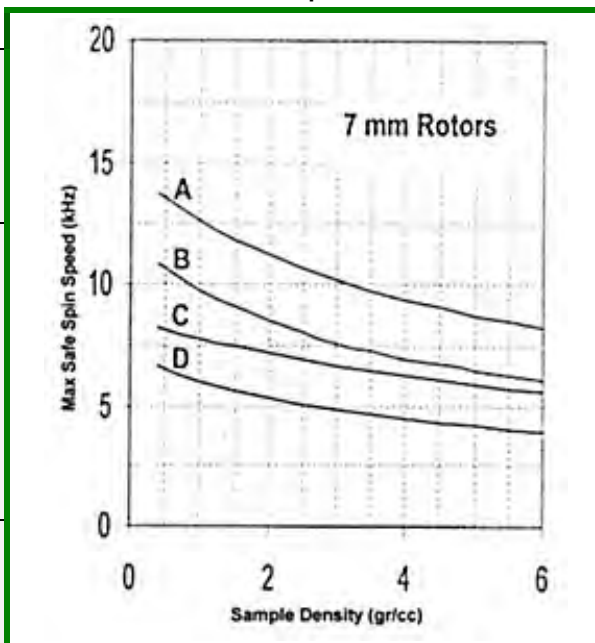

## MAS Turbine Cap Spinning Speeds

Maximum Spinning Speeds (kHz) For Caps at Room Temperature

Cap Style	4 mm	5-mm XC or SuperSonic	5-mm Standard & High-Speed	7-mm XC or SuperSonic	7-mm Standard & High-Speed	10-mm XC, SuperSonic
Kel-F	11	10	9	7	6	5
Torlon or GFT	22	18	14	12	9	8.5
Vespel	21	16	14	12	9	8
Aurum	22	18	14	12	9	8.5
Caps with o-rings	-----	10	9	7	6	5
Vespel w/screw	-----	-----	9	12	11	8

**Note:** This chart represents only material characteristics for caps. Check the Probe Specifications. The spinning speed is often more limited by the probe or the rotor material.



## 3 mm Maximum MAS Spinning Speeds

Use the lower of the speeds listed: considering the rotor, the cap, the temperature and the density maximum speeds

<b>Rotors: <i>The maximum speed must be reduced as the density of the sample increases.</i></b>		
DI3 Silicon Nitride Rotors Maximum Speed	28 KHz	For sample density = 1
	26 KHz	For sample density = 3
Maximum Spinning Speeds (kHz) For <b>Caps</b> at Room Temperature		
Cap Style	DI-3 Spinning at Room Temperature	Cap Material Temperature Range
Torlon Front Turbine Cap	28 KHz	-30° to 80 °C
Torlon Rear Tip Cap	28 KHz	
GFT* Front Turbine Cap	26 KHz	-120° to 160 °C
GFT* Rear Tip Cap	26 KHz	
Aurum Front Turbine Cap	18 KHz	-30° to 80 °C
Aurum Rear Tip Cap	18 KHz	
Kel-F Front Turbine Cap	11 KHz	-20° to 70 °C
Kel-F Rear Tip Cap	11 KHz	
<b><span style="color: green;">*Maximum Spinning Speeds (KHz) For Caps at Extended Temperatures</span></b> Spinning speeds must be reduced for higher or lower temperatures.		
Glass Filled Torlon (GFT)*	14 KHz <b>At -80°C</b>	-120° to 160 °C
Glass Filled Torlon (GFT)*	14 KHz <b>At +120°C</b>	-120° to 160 °C

\* Note: **GFT caps** can be used up to 250 °C or down to -170 °C if they are glued in with epoxy. **However the probe must be rated for these extended temperatures.**

## Typical Specifications for Solids Probes

CRAMPS, Wide Line, MQ/MAS, H/F/X or F/X MAS,

Double-tuned, or Triple-tuned Probes

Although the versatile XC MAS probe can be supplied with one to four channels and upgraded at a later date, many customers prefer to order dedicated-purpose probes for lower cost or for specific requirements. Doty provides dedicated **CRAMPS, WIDELINE, Double-tuned, Triple-tuned, MQ/MAS, and HFX MAS**, to name a few. The following table provides typical specifications for some of these probes for the NB 500 MHz spectrometer. Specifications for other probes are available upon request.

<b>500 MHz NB Solids. Standard Resolution. (For 40 mm RT shim bore, 5 mm sample.)</b>												
Brief Description	VT range °C	Spinner, kHz	H/F $\gamma B_1$ kHz	H/F P W	H/F dec. ms	Salt Toler.	$^{13}\text{C}$ $\pi/2$ $\mu\text{s}$	$^{13}\text{C}$ Power W	S/N, 4t	Wideline Backgrounds $^1\text{H}$ $^{19}\text{F}$ $^{13}\text{C}$		
$^1\text{H}$ CRAMPS	-80/+120	Std, 1-9	160	400	-	High	-	-	-	~Zero	High	-
X WL	-80/+120	0	-	-	-	High	2.0	450	-	Mod.	High	Low
$^2\text{H}$ WL	-80/+120	0	-	-	-	High	$^{2.0}$ $^2\text{H}$ 90	975	-	Mod.	High	Low
H/X WL	-80/+120	0	120	300	150	High	2.6	700	240 <sup>A</sup>	Mod.	High	Low
<b>500 MHz NB HR MAS Solids. XC Fast Spinner. (For 40 mm RT shim bore, 5 mm sample.)</b>												
Brief Description	VT range °C	Spinner, kHz	H/F $\gamma B_1$ kHz	H/F P W	H/F dec. ms	Salt Toler.	$^{13}\text{C}$ $\pi/2$ $\mu\text{s}$	$^{13}\text{C}$ Power W	S/N, 4t	Wideline Backgrounds $^1\text{H}$ $^{19}\text{F}$ $^{13}\text{C}$		
H/X MAS*	-80/+120	XC 2 -18	65	190	50	Mod.	4.6	200	390 <sup>A</sup>	Mod.	High	Low
H/X MAS*	-160/+150	XC 2 -18	65	190	50	Mod.	4.6	200	390 <sup>A</sup>	Mod.	High	Low
H/X MAS	-80/+120	XC 2 -18	120	300	100	High	3.6	400	190 <sup>B</sup>	Mod.	High	Low
H/X MAS	-160/+150	XC 2 -18	120	300	100	High	3.6	400	190 <sup>B</sup>	Mod.	High	Low
F/X MAS	-160/+150	XC 2 -18	120	330	100	High	3.6	400	180 <sup>B</sup>	M. High	None	M. Low
H/X MAS/PFG	-15/+60	XC 2 -18	55	200	50	Mod.	4.6	225	390 <sup>A</sup>	Mod.	High	Low
H/X/Y MAS	-15/+60	XC 2 -18	120	300	100	High	3.6	400	180 <sup>B</sup>	Mod.	High	Low
H/X/Y MAS	-160/+150	XC 2 -18	120	300	100	High	3.6	400	180 <sup>B</sup>	Mod.	High	Low
H/F/X MAS	-80/+120	XC 2 -18	80/80	420	100/80	High	4.6	450	170 <sup>B</sup>	High	None	Mod.
H/F/X MAS	-160/+150	XC 2 -18	80/80	420	100/80	High	4.6	450	170 <sup>B</sup>	High	None	Mod.
H/F/X MAS	-160/+150	XC 2 -18	80/80	420	100/80	High	4.6	450	170 <sup>B</sup>	Mod.	High	Low
H/F/X MAS	-80/+120	XC 2 -18	80/80	420	100/80	High	4.6	450	170 <sup>B</sup>	Mod.	High	Low

All the above data are for 5 mm. S/N at RT; NF=1.2. **A:** non-spinning CP at 90° on HMB. **B:** CPMAS on glycine. Specifications listed for Triple Resonance probes are for DT configuration. For "High salt" probes, maximum X-channel  $B_1$  is degraded during CP by ~20%, but ~40% for "Moderate salt" probes.  
\* Also available with SuperSonic Spinner. Specifications subject to change.





## Ordering Information

### Probes Are Available for All Spectrometer Users

- ◆ Bruker ◆ JEOL ◆ Tecmag ◆ Agilent/ Varian/ Chemagnetics
- ◆ Siemens ◆ GE ◆ Custom

### Pricing

- ◆ **There is a \$50 minimum per order.**
- ◆ For probe prices, please request a quotation. This enables us to confirm prices and specifications.
- ◆ Shipping and handling charges will be prepaid and added to the invoice.
- ◆ **Pricing is for U.S. domestic sales and subject to change without notice.**  
Add 5% plus customs duties for Canada.  
Add 15% plus customs duties for foreign sales.

Volume Discounts For Rotors, Caps and Other Small Items		
Price Per Item	Quantity Per Line Item	Discount
under \$ 100	4-9	10%
under \$ 100	10 or more	20%
\$100 - \$ 400	4-9	10%
\$100 - \$ 400	10 or more	15%
\$401 - \$1000	4-9	5%
\$401 - \$1000	10 or more	10%

### Doty Scientific Warranty Information

DSI warrants that its products will conform to the specifications quoted when used with reasonable care within specifications, and in conjunction with properly performing instruments, for a period of one year from the date shipped. Exceptions: (1) Rotors and turbine caps are not covered under warranty because rotors and caps may be damaged by IMPROPER handling. Please follow the instructions in your manual. (2) Probe VT components may not be covered under warranty unless the probe is used with a DSI VT controller. Products requiring service or modification may be returned with freight, insurance, and handling fees prepaid. DSI will return repaired products freight prepaid. DSI assumes no responsibility for the repair or modification of products not provided by Doty Scientific.



MasterCard and Visa Are Accepted



## Sales Offices

### For Sales and Service in the USA:

#### **DOTY SCIENTIFIC, INC.**

700 Clemson Road Columbia, SC 29229 USA

Phone: 1 (803) 788-6497 Fax: 1 (803) 736-5495

E-mail: [sales@dotynmr.com](mailto:sales@dotynmr.com),

E-mail: [service@dotynmr.com](mailto:service@dotynmr.com)

Website: [www.dotynmr.com](http://www.dotynmr.com)

### For European Sales and Service:

#### **ROTOTEC-SPINTEC GmbH**

*David H. Cross, President*

Laienberg Str. 112  
75323 Bad Wildbad

GERMANY

Phone: +49 (0) 7081 380 3851

Fax: +49 (0) 7081 380 3852

E-mail: [info@rototec-spintec.com](mailto:info@rototec-spintec.com)

Website: [www.rototec-spintec.com](http://www.rototec-spintec.com)

### For Sales and Service in Japan:

#### **L.A. Systems, Inc.**

*Takao Okada, Ph.D. President*

Tokei-Kaikan Bldg. 1F 1-11-5

Ueno, Taito-ku  
Tokyo, 110-0005,  
JAPAN

Phone: +81-3-5812-5311

Fax: +81-3-5807-4050

Email: [support@las.jp](mailto:support@las.jp)

Website: [www.las.jp](http://www.las.jp)

### For Sales in France and Belgium:

#### **RS2D**

ZA des Marechaux – 13, Rue Vauban  
67450 MUNDOLSHEIM  
FRANCE

Phone: +33 (0)390405400

Fax: +33 (0)390405410

E-mail: [contact@rs2d.com](mailto:contact@rs2d.com)

Website: [www.rs2d.com](http://www.rs2d.com)

### For Sales and Service in Korea:

#### **BK Instruments Inc.,**

*Gee-Duk Jeon, President / CEO*

4F, BKI Bldg., 281-25, Munji-Ro,  
Yuseong-Gu, Daejeon, 34050,  
SOUTH KOREA

Phone: +82 (0) 42 487 8240

Email: [gdjeon@bkinstruments.co.kr](mailto:gdjeon@bkinstruments.co.kr)

Website: [www.bkinstruments.co.kr](http://www.bkinstruments.co.kr)